

# ECLIPSE®

by FUJITSU TEN

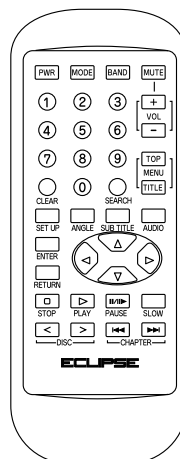
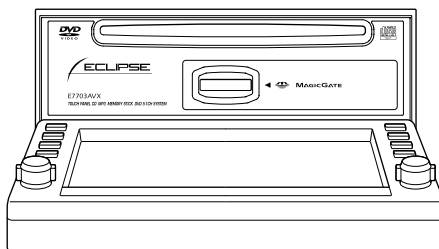
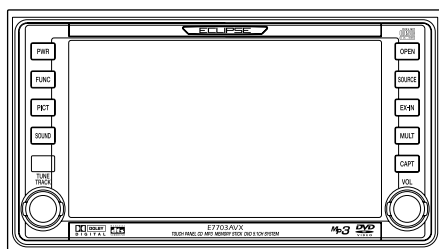

MODEL **E7703AVX**

Multi Control DVD-Video / MS AV System

## OWNER'S MANUAL

We appreciate your purchase of this tuner.  
Please read through this manual for correct operation.  
We suggest that after reading it you keep this manual  
in a safe place for future reference.

# ***For your safety in using the E7703AVX***

Warnings and caution signs, illustrated below, are posted throughout this manual as well as on the E7703AVX. They show safe and correct ways to handle the product so as to prevent personal injury to you and others and avoid damage to property.

Before reading through the manual, take time to read through and learn the important information listed in this section.



**Warning**

This sign indicates a situation in which incorrect handling through disregard of a sign might result in death or serious personal injury.



**Caution**

This sign indicates a situation in which incorrect handling through disregard of a sign might result in personal injury or may result solely in damage to property.



**Warning**

---

- Do not watch moving images on the display while driving. Doing so may lead to an accident resulting in serious injury or death.
- Do not modify this system for use other than that specified herein. Also, do not deviate from the installation procedures described herein; Eclipse will not be held liable for damages including, but not limited to serious injury, death or property damage resulting from installations that enable unintended operation.
- This unit is intended for operation in DC 12-volt, negative-grounded vehicles only. Never use it in 24-volt vehicles such as heavy trucks or diesel cars with cold-region specifications.
- Do not change disc or Memory Stick while driving. Doing so may result in an accident.

---

 **Warning**

---

- Do not place the vinyl storage bag over a person. It may cause a serious accident or death by suffocation.
- Do not adjust the controls while driving the car. To adjust the controls, stop the car in a safe location.
- To prevent accidents, store batteries for the remote control out of the reach of small children. In case a child swallows a battery, consult a physician immediately.
- Do not disassemble or rebuild this product. Doing so may cause an accident, fire or electrical shock.
- When it is necessary to replace the fuse, always use a fuse of the correct rating (number of amperes). Use of fuses with higher amperage ratings may cause a fire.
- Do not operate the product in a malfunctioning condition, for instance, when the audio does not play. Doing so may result in an accident, fire or electrical shock.
- If an abnormal situation occurs, such as foreign matter entering or liquid splashing on the product, or smoke or a strange odor emitting from the unit, shut off the product immediately and consult the dealer from whom you purchased it. Continued operation may cause an accident, fire or electrical shock.
- Do not install this product in locations where it may obstruct the driver's view, or where it may endanger passengers in the vehicle. Otherwise, an accident or injury may result.
- Do not install this product in locations where it may interfere with the operation of the steering wheel, shift lever, brake pedal, etc. Otherwise, an accident or injury may result.
- When installing this product, never use existing nuts or bolts that secure parts of the fuel tank, or the steering or braking systems. Otherwise improper steering or braking or a fire may result.

---

 **Warning**

---

- To prevent a short circuit from occurring, disconnect the battery's negative terminal before installing this product. Otherwise, an electric shock or injury may result.
- When using an existing nut and/or bolt from the vehicle to ground this product, do not use any that secure parts of the steering or braking systems. Otherwise, an accident may result.
- Bundle cables and harnesses with electrical tape or wire ties to prevent them from interfering with moving parts. If they should entangle the steering wheel, shift lever or brake pedal, an accident may result.
- Never supply power to another electrical appliance by splicing or tapping into this product's power lead (wire). Otherwise, the current capacity of the wire will be exceeded, resulting in a fire or electric shock.
- Never attempt to disassemble or modify the product. Otherwise, an accident, fire or electric shock may result.
- When installing the product into a vehicle with a passenger side air bag, do not secure it to the air bag's cover or in places where it may impede air bag deployment. Otherwise, proper air bag operation may not be ensured in the event of an accident, causing injury or death.
- When making holes using a drill or similar tool, be sure to wear protective eyewear. Otherwise, an injury such as loss of eyesight may result.
- Exposed wires must be insulated with electrical tape. Otherwise, a short circuit, fire, or electric shock may result.

---

 **Caution**

---

- Play the audio at a moderate volume level that permits you to hear sounds from outside the car. Driving without being able to hear outside sounds may result in an accident.
- Keep foreign objects out of the disc or Memory Stick slot. They may cause fire or electrical shock. Another possibility is that discs may be damaged or become stuck.
- Do not stick your fingers or hands into the disc or Memory Stick slot. Doing so may cause personal injury.
- This product must be operated only as on-board equipment, or it may cause electrical shock or injury.
- Do not play distorted sounds for long periods of time; the speakers may overheat and cause a fire.
- This product uses an invisible laser light. In case a problem develops, be sure to consult the dealer from whom you purchased the product. Do not disassemble or rebuild the unit; rebuilding it may expose you and others to a dangerous laser emission (which would damage eyesight) or cause an accident.
- Never use batteries other than those specified. Do not mix new and old cells. Doing so may cause a fire or personal injury due to a battery explosion or chemical leaks.
- Pay attention to the (+) and (-) polarity of the battery when installing them in the product. Incorrect installation may cause personal injury or product damage spoilage due to a battery explosion or chemical leakage.
- For best results, this product should be installed by a professional installer.  
Contact the dealer whom you purchased the product for an appointment.
- When installing this product, be sure to use the supplied mounting hardware. If parts other than those supplied are used, the unit may be damaged internally, or may not be held in place securely and become dislodged.



## Caution

---

- Avoid installing this product in places where it may get wet, such as near windows, or in places that are moist or dusty. Presence of liquid, moisture or dust inside this product can cause short circuiting, resulting in smoke or fire.
- Do not install this product in locations where it cannot be fastened securely, such as places subject to frequent vibration. Otherwise, it may become dislodged and cause an accident or injury.
- Do not block this product's vent or heat sink. If either is blocked, excessive heat build-up may occur and cause a fire.
- If this product is not connected properly, a short circuit, fire or accident may occur.
- When routing cables, use care so that they do not contact sharp metal parts such as brackets or screw tips. Otherwise, a short circuit, electric shock, fire or accident may result.
- Do not obstruct the vent on this product. If blocked, excessive heat build-up may occur and cause a fire.

# Table of Contents

<b>Operating precautions .....</b>	<b>11</b>
Notes on using the system .....	11
About discs .....	13
About cleaning a disc .....	16
About Memory Sticks .....	17
About cleaning Memory Sticks .....	18
About cleaning unit .....	18
 <b>Names of parts .....</b>	 <b>19</b>
 <b>Basic operation .....</b>	 <b>22</b>
Inserting a DVD/CD/Memory Stick .....	22
Ejecting a DVD/CD/Memory Stick .....	24
Adjusting the display angle.....	26
Turning power on/off .....	28
Switching to other modes .....	28
Adjusting the main volume .....	31
Displaying the sound adjustment screen.....	32
Setting position/volume balance.....	34
Setting loudness.....	35
Setting the subwoofer.....	36
Setting MP3 sound correction (MP3 harmonizer) .....	37
Setting DSP.....	38
Setting EQ(Equalizer).....	40
Adjusting the surround system .....	44
Setting speaker size .....	50
Setting time alignment/output level .....	52
Adjusting image quality .....	55
Switching screen background .....	57
Changing the touch switch display .....	59
Saving and exporting image data .....	60
Capturing images .....	64
Changing the clock settings .....	66
Setting guide tones.....	67
Setting the reverse linking function for the back-eye camera.....	67

***How to operate the tuner ..... 68***

Listening to tuner.....68  
Selecting a broadcast station .....68  
Presetting stations automatically.....69  
Presetting stations manually .....70  
Checking preset stations .....70  
FM reception characteristics .....71

***How to operate the CD player..... 73***

Listening to CD.....73  
Advancing to the next track or returning to the  
beginning of the track being played.....73  
Fast Forward/Rewind .....74  
Playing the beginning of tracks (SCAN).....74  
Repeating the same track (REPEAT).....74  
Playing tracks in random order (RANDOM) .....74  
Creating a title for a CD.....75  
Deleting a previously created title .....76  
Displaying CD TEXT by scrolling .....77

***How to operate the MP3 player ..... 78***

About MP3.....78  
Listening to MP3 files .....81  
Selecting a folder to listen to .....82  
Selecting a file to listen to.....82  
Displaying the next higher-up level .....83  
Playing the beginning of tracks (SCAN) .....83  
Repeating the same track (REPEAT).....84  
Playing tracks in random order (RANDOM) .....84

***How to operate the Memory Stick player ..... 85***

Listening to Memory Stick .....85  
Advancing to the next track or returning to the  
beginning of the track being played.....85  
Playing the beginning of tracks (SCAN) .....86  
Repeating the same track (REPEAT).....86  
Playing tracks in random order (RANDOM) .....86  
Recording on Memory Stick .....87  
Editing recorded Memory Stick .....90



**How to operate the DVD player ..... 95**

Before using the DVD player.....	95
Watching a DVD.....	99
Using the menu screen.....	100
Fast-Forward/Rewind.....	101
Pausing/Advancing the video.....	101
Stopping playback.....	102
Using slow motion.....	102
Searching for a desired chapter.....	103
Playing the beginnings of chapters (SCAN).....	104
Repeating titles (REPEAT).....	104
Switching the video angle.....	105
Switching subtitle languages.....	106
Switching dubbed voice languages.....	106
Setting the DVD player.....	107
Table of language codes.....	117

**How to operate the video CD player ..... 119**

Watching a video CD.....	119
Using the menu screen.....	120
Advancing to the next scene or returning to the beginning of the scene being played.....	121
Fast-Forward/Rewind.....	121
Specifying a track to playback.....	122
Pausing/Advancing the video.....	122
Stopping playback.....	123
Using slow motion.....	123
Switching sound output.....	123

**How to operate multi-window display ..... 124**

Setting multi-window.....	124
Switching multi-window display.....	125
Adjusting multi-window display size.....	125

**How to operate the receiver with an optional navigation system connected  
(In case of using the receiver as monitor for navigation system).... 126**

Using the receiver as monitor for navigation system.....	126
--	-----

***How to operate the receiver with an optional  
CD changer connected..... 127***

Listening to a CD .....127  
Advancing to the next track or returning to the  
beginning of the track being played.....127  
Fast-Forward/Rewind .....128  
Playing the beginning of tracks (SCAN) .....128  
Repeating the same track (REPEAT).....128  
Playing tracks in random order (RANDOM) .....129  
Specifying a CD to play .....129  
Creating a title for a CD .....130  
Deleting a previously created title .....131

***How to use the remote control ..... 132***

Precautions in use of the remote control .....132  
Cleaning the remote control .....132  
Turning the power on/off .....133  
Adjusting the audio volume .....133  
Switching playback modes .....133  
How to play the tuner .....134  
How to play CD .....135  
How to play Memory Stick .....136  
Replacing the battery .....137

***Troubleshooting ..... 138***

Message displays .....138  
Before asking for repairs .....141

***Specifications ..... 145***

# Operating precautions



Be very careful and pay full attention to safety when operating the audio controls while driving, otherwise accidents may occur.

## Notes on using the system

- Some functions cannot be used while driving. These functions will appear in lighter color than normal to indicate that they cannot be used.
- For safety, keep the volume at a low enough level so that sounds outside the vehicle can still be heard while driving.
- Never continue to use the system if it is malfunctioning in any way.  
If smoke, abnormal noises or abnormal odors are noticed, turn off the power immediately.
- The driver should avoid operating the system as much as possible while driving.
- Do not apply excessive force to the monitor, otherwise it may become damaged.
- Do not place items such as cups or cans on top of the monitor, and do not leave the monitor tilted down when not in use, otherwise damage may occur.
- Never insert foreign objects such as coins, plastic cards into the disc insertion slot. The only objects that should be inserted into this slot are the appropriate CDs, DVDs, and Memory Sticks. Be particularly careful not to let children interfere with the system.

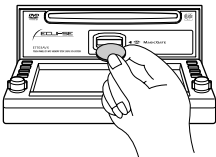
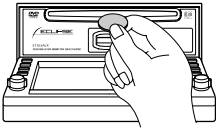

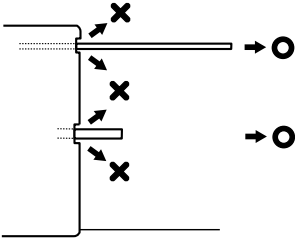

- Be sure to keep discs and Memory Sticks horizontal when removing them from the unit. Do not pull them up forcibly or press down on them strongly while removing them, otherwise discs may become scratched and the sound may skip, and Memory Sticks may also become damaged.

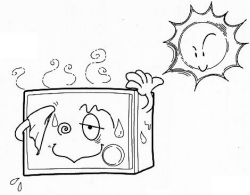

- The temperature inside the vehicle can increase during hot weather. Wait for the temperature inside the vehicle to drop before using the unit.



- Avoid humid environments. If liquid gets inside the unit or onto it, malfunctions or damage may occur. Be particularly careful of items such as drinks that have been placed in drink holders that are near the unit.



- The components inside of the unit have been assembled with high precision, and they should not be disassembled or modified. If a problem occurs with the unit, contact the place of purchase.

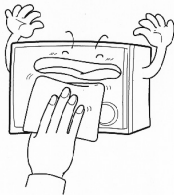

- Clean the unit by wiping it with a soft, dry cloth. If it is particularly dirty, use a cloth that is lightly moistened with alcohol.

## About discs

- Water droplets can form on the inside of the unit during cold or rainy weather in the same way car windows can fog up. (This is condensation.) When this happens, the audio can jump and playback can stop, so ventilate or dehumidify the vehicle for a short time before operating the equipment.
- To safeguard the components of the player, the unit will automatically stop when a malfunction occurs. If the player will not operate even when messages displayed on the screen are followed, consult with your equipment retailer because it is possible that the unit has been damaged.
- It is possible that the sound will skip if the vehicle experiences violent motion on rough roads.
- It is possible that a copy protected CD will not play on the unit.
- It is possible that a CD-R (CD-Recordable) or CD-RW (CD-ReWritable) disc will not play on the unit due to special disc characteristics, scratches, dirt or deterioration caused by long storage in the vehicle. In addition, a CD-R or CD-RW disc written with CD-R, CD-RW or UDF format that has not been finalized will not play on the unit.
- An audio disc or DVD video disc bearing one the marks on the left can be played.





- A DVD disc bearing one of the marks at left for Dolby Digital (5.1 ch) or DTS (5.1 ch) \*1 or can also be played.

\*1 Center speaker and subwoofers (sold separately) are required for playing Dolby Digital (5.1 ch) or DTS (5.1 ch).

\*2 Manufactured in compliance with rights granted from Dolby Laboratories. Dolby and the double D mark are trademarks of Dolby Laboratories.

\*3 DTS is a trademark of Digital Theater System, Inc.

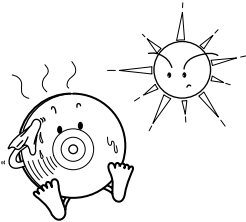

- Place discs in their protective cases and store in a location out of direct sunlight, high temperature and high humidity.

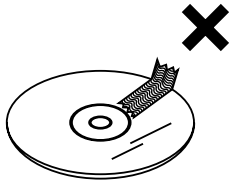

- Do not place adhesive materials on either the recorded side or label side of a disc, and do not write on a disc or scratch it.

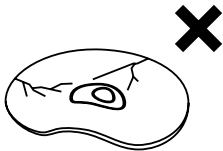

- Do not use CD discs with attached cellophane tape, rental CD discs with glue protruding from labels or discs with the residue of peeled adhesives. Using discs with those conditions can prevent the player from properly opening and closing as well as cause other damage.

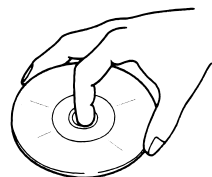

- Discs spin at high speed inside the unit. Do not use a cracked CD disc because it can cause the disc to damage the CD unit.
- Do not touch the recorded side of a disc when handling it.

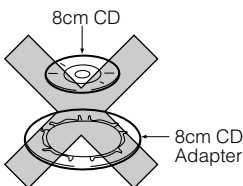
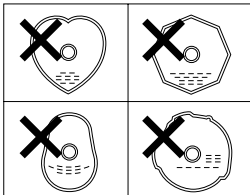
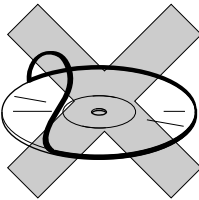
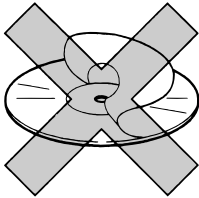
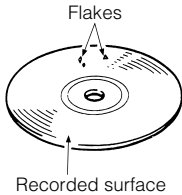
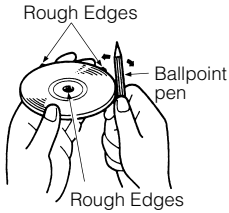

- You may notice that some brand new discs are rough around the center hole or outside edge. Remove the rough edges with the side of a ballpoint pen, etc. Rough edges may prevent proper loading in the unit. Flakes from the rough edges may also stick to the recorded surface and interfere with playback.

- Do not use accessories (stabilizers, protective seals, laser lens cleaners, etc.) sold for "improving sound performance" or "protecting CDs." The changes in CD thickness or outside dimensions made by these accessories may cause problems in the player.

- Please be sure NOT to attach any ring-shape protector (or other accessory) to your discs. Those protectors are commercially available and said to protect disc and to improve sound quality (and antivibration effect), but they can do more harm than good in regular uses. The most common problems are insert/Eject related problems and "No playback" problems due to the protector ring that come off in the disc mechanism.

- Specially-shaped or octagonal CDs, like heart-shaped cannot be played. Do not attempt to play them, even with an adapter, since they may damage the player.

- The unit can play 8 cm CDs without the need for an adapter.

- Do not play back 8 cm CDs with a single adapter attached, as malfunctions may occur if such discs are used.

## About cleaning a disc



- Use a commercially available compact disc cleaner to clean a CD, wiping lightly from the center to the edge.

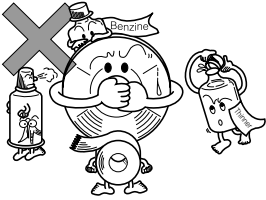

- Do not use benzine, thinner, LP record spray or other cleaners on CDs. They may damage a CD's finish.

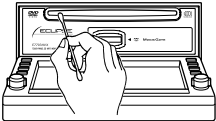

- The disc slot tends to get dusty. Clean it occasionally to prevent accumulated dust from scratching the discs.





## About Memory Sticks

- Do not store Memory Sticks in places that are subject to static electricity and electrical interference, otherwise the data they contain may become corrupted.
- In order to protect the player, the player's functions will be stopped automatically if a problem occurs. If the player cannot be operated even after following the instructions that appear on the screen, the unit is malfunctioning, and you should ask the place of purchase for further advice.
- If using a Memory Stick Duo, you will need to use it with a Memory Stick Duo adapter.
- Only Memory Sticks with a capacity of up to 128 MB can be used in the unit.
- Memory Stick PRO types of Memory Stick cannot be used.
- After playing back a MG Memory Stick and after transferring data to a MG Memory Stick or other Memory Stick, remove the Memory Stick immediately.
- MG Memory Sticks bearing one of the marks at the left can be used.
- Memory Sticks bearing one of the marks at the left can be used for loading images into the unit and for saving captured images.

**MAGICGATE**



MagicGate Memory Stick  and Memory Stick  are trademarks of Sony Corporation.

- If the write protection switch on a MG Memory Stick or Memory Stick is at the lock position, audio recordings and other data cannot be saved onto it.
- Do not remove a MG Memory Stick while it is being accessed for playback or recording, otherwise the data on the MG Memory Stick may become corrupted. If the data becomes corrupted, it can no longer be retrieved.
- Formatting (initializing) MG Memory Sticks requires special equipment. If a MG Memory Stick is formatted using some other type of equipment, you will not be able to play it back on this unit.
- It may not be possible to use MG Memory Sticks that have just been purchased. If this happens, use the unit to format the MG Memory Stick. Refer to "Formatting Memory Stick (quick format)" on page 89 for instructions on formatting MG Memory Sticks.
- Some recordings and other data may not be played back or displayed, depending on the device that was used to save the data.

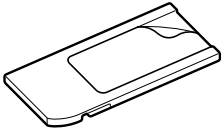

- Do not use Memory Sticks with labels that are peeling off or that have name tags (labels) attached.

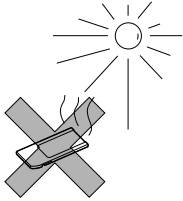

- Store Memory Sticks in places away from direct sunlight and high humidity, otherwise the Memory Sticks may become unusable.

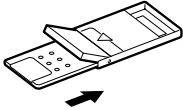

- Place Memory Sticks in their protective cases during transportation and storage.

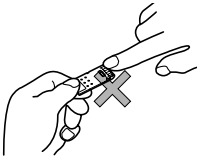

- Do not touch the terminals with your hands or with metallic objects.

## About cleaning Memory Sticks

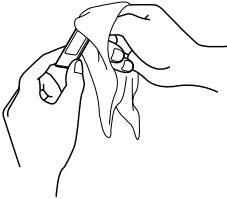

- In order to maintain good audio performance from Memory Sticks, periodically wipe the cartridge clean of any dust and other contamination with a dry cloth.

## About cleaning unit

- Use a soft cloth (such as a silicon cloth) to clean the unit.  
If it is particularly dirty, use a cloth that is lightly moistened with a weak solution of household detergent.  
Be particularly careful when wiping the touch panel, as it scratches easily.  
If using a chemically-treated cloth, follow the instructions provided with the cloth.
- Do not use volatile solvents such as acetone or thinner, as they can cause discoloration and peeling of the unit's finish.

# Names of parts

The unit can be operated by pressing buttons on the frame of the panel (panel buttons) and by touching buttons displayed on the screen (touch switches). The remote control can also operate the unit, and some DVD operations can only be controlled by the remote control.

## Panel Buttons

[Unit Front Surface]

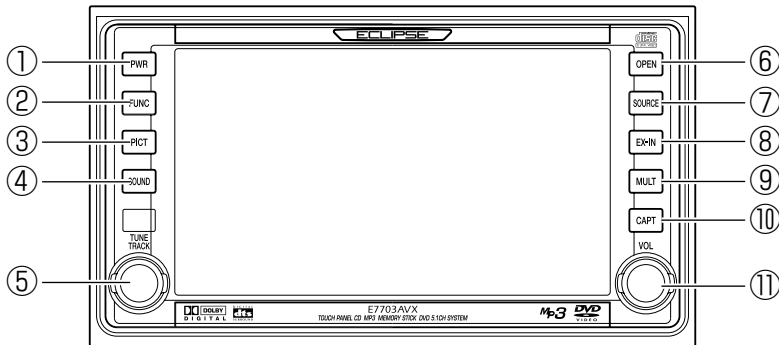

①	PWR Button	Turns power on and off.
②	FUNC Button	Switches to Function Mode.
③	PICT Button	Switches to Screen Adjustment Mode to allow adjustment of image quality and screen background (background screen/animation).
④	SOUND Button	Switches to Sound Adjustment screen.
⑤	TUNE TRACK Button	Selects radio stations and fast forwards or rewinds discs.
⑥	OPEN Button	To insert and eject discs/Memory Sticks. To adjust display viewing angle.
⑦	SOURCE Button	Displays the Audio Menu screen and switches between audio modes.
⑧	EX-IN Button	Switches to external navigation screen.
⑨	MULT Button	Activates display of multiple windows.
⑩	CAPT Button	Switches to Image Capture Mode.
⑪	VOL Button	Adjusts volume.

[With Display Open]

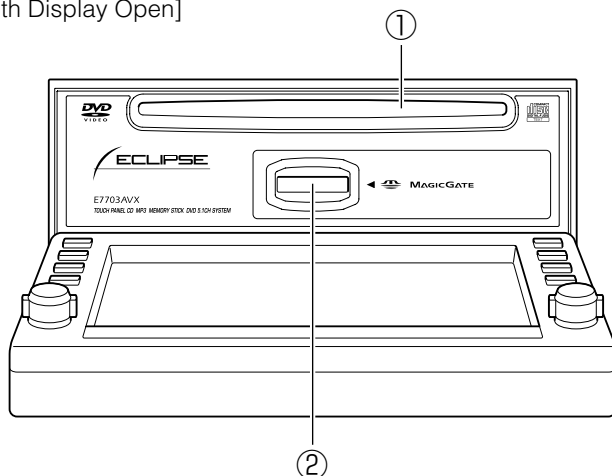

① Disc Insertion Slot	Slot for insertion/ejection of CD and DVD discs.
② Memory Stick Insertion Slot	Slot for insertion/ejection of Memory Sticks.

## Touch Panel

### Touch switch

Unit can be operated by touching buttons on screen.

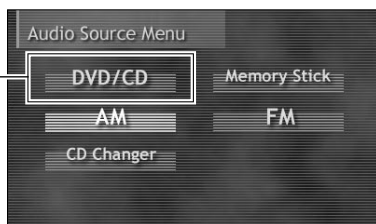

### [About operation of touch switch]

- Touch the buttons until a beep sound is emitted.
- Touch the buttons lightly to prevent damage to the screen.
- If a button does not respond, remove your finger and touch it again.
- An unavailable button is shaded.
- Button color may continue with activated appearance while the function is being performed.

### [About button and switch display in this manual]

- Panel button names are shown with light background ([PWR], [FUNC], etc.).
- Touch switch names are shown with dark background (  ).



Caution

If the screen becomes dirty, clean it by lightly wiping with a soft dry cloth such as an eyeglass tissue meant for plastic lenses.

## Remote Control

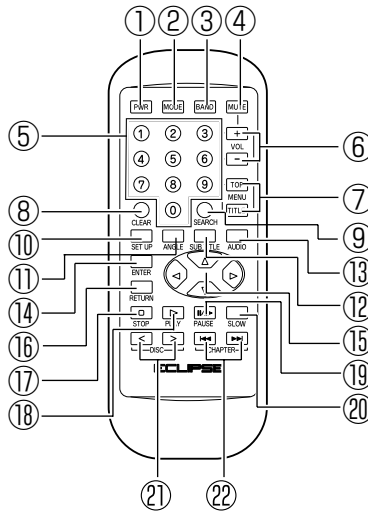

①	PWR Button	Turns power on and off.
②	MODE Button	Switches audio source mode.
③	BAND Button	Switches radio band and video CD menu.
④	MUTE Button	Mutes audio and cancels mute.
⑤	NUMBER Button	Searches for DVD chapters.
⑥	VOL Button	Adjusts volume.
⑦	MENU Button	Displays DVD menu and Title menu.
⑧	CLEAR Button	Clears numbers currently being input.
⑨	SEARCH Button	Switches between search for DVD chapters and DVD titles.
⑩	SET UP Button	No function set at this time.
⑪	ANGLE Button	Switches the angle of the DVD.
⑫	SUB TITLE Button	Switches subtitles during DVD playback.
⑬	AUDIO Button	Switches voices during DVD playback.
⑭	ENTER Button	Sets the content for each setting.
⑮	△(cursor) Button	Moves cursor during operation of DVD menu.
⑯	RETURN Button	Returns to previous screen.
⑰	STOP Button	Stops video playback.
⑱	PLAY Button	Starts (restarts) video playback.
⑲	PAUSE Button	Pauses video playback.
⑳	SLOW Button	Activates slow-motion video playback.
㉑	< DISC > Button	Selects disc in CD changer or selects radio preset channels.
㉒	◀ CHAPTER ▶ Button	Selects DVD chapter and disc track.

## Basic operation

This section explains basic operations for use of the AVX equipment. For detailed information, refer to special explanations for each function.

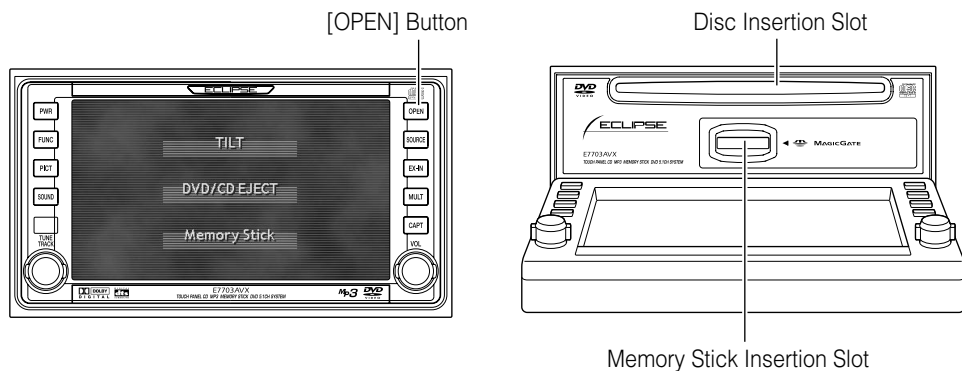

## Inserting a DVD/CD/Memory Stick

To listen to music, insert a music CD or memory stick. To play a video, insert the DVD or video CD into the insertion slot.

- 1 Press the [OPEN] panel button.

Switches display to the Display Open/Tilt selection screen.

- 2 Touch the **DVD/CD EJECT** or **Memory Stick** touch switch.

Opens display to reveal insertion slots.



Caution

If the vehicle's automatic transmission shift lever is in the "P" position or manual transmission lever is in the 1, 3, 5 or "R" position, or if a bottle or other container is in the cupholder, this could interfere with the opening and closing of the display. When it is safe to do so, move the shift lever to the "N" or "Neutral" position or remove the container from the cupholder before opening or closing the display.

### 3 Insert the disc or memory stick into the insertion slot.

#### <Disc insertion>

The disc will be drawn into the unit and the display will automatically close.

- When a DVD or video CD is inserted, video playback will start.
- When a music CD is inserted, CD audio playback will start.



Insert discs with labels facing upwards.

#### <Memory Stick insertion>

After the Memory Stick has been inserted, press the [OPEN] panel button to close the display.



- Insert Memory Sticks with the mark facing inwards and press Memory Stick into place until a clicking sound is heard. Do not press forcefully when the Memory Stick makes contact with the internal stopper because it cannot be inserted any further.  
(The Memory Stick should be protruding a few millimeters from the insertion slot.)
- Use a Memory Stick Duo adapter when inserting a Memory Stick Duo. (If the Memory Stick Duo is inserted without the adapter, it will not be ejected from the unit.)



- Do not press the [OPEN] button while the disc or Memory Stick is being inserted. This could cause an injury or damage to the display.
- DVD video discs and CD discs use the same insertion slot, so use one function or the other as needed.
- Do not insert map discs (DVD-ROM) because these cannot be used with this equipment.

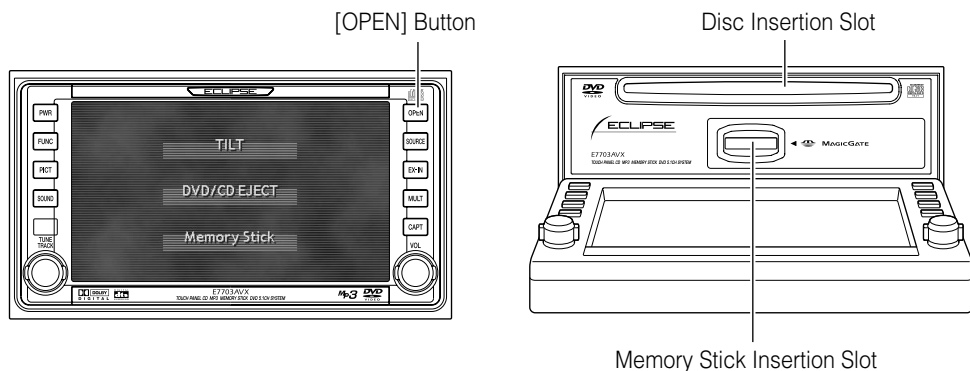

## Ejecting a DVD/CD/Memory Stick

- 1** Press the [OPEN] panel button.

The display switches to the Display Open/Tilt selection screen.
- 2** Touch the **DVD/CD EJECT** or **Memory Stick** touch switch to eject the disc or Memory Stick.

<Disc ejection>

Touch the **DVD/CD EJECT** touch switch and the disc will be automatically ejected.



If the disc is not ejected (stuck), touch the **DVD/CD EJECT** touch switch for 5 seconds or more. The disc will be ejected.

### <Memory Stick ejection>

Touch the **Memory Stick** touch switch and the display will open. Then lightly press the Memory Stick one time.





Caution

- If the vehicle's automatic transmission shift lever is in the "P" position or manual transmission lever is in the 1, 3, 5 or "R" position, or if a bottle or other container is in the cupholder, this could interfere with the opening and closing of the display. When it is safe to do so, move the shift lever to the "N" or "Neutral" position or remove the container from the cupholder before opening or closing the display.
- Be careful of the following items while a disc is being ejected.
  - <Automatic transmission vehicle>  
If the shift lever in the "P" position causes interference with disc ejection, switch the lever to the "N" position to eject discs. (Steering column mounted shift levers allow unit operation while lever is in either "P" or "N" position.)
  - <Manual transmission vehicle>  
If the shift lever in the 1, 3, 5 or "R" position causes interference with disc ejection, switch the lever to the Neutral position to eject discs.

**3****Press the [OPEN] panel button after ejection.**

The display will close.



ATTENTION

After a disc is ejected and the display closes, the sound of a disc spinning operation (reading) can be heard, but it will stop after a few seconds. This is not an equipment malfunction.



Caution

- Do not close the display by hand. This could damage the display.
- Do not place objects such as cups or cans on the display when it is in the open position. This could damage the display.
- If a liquid such as a beverage is spilled on the display, immediately clean the display by wiping with a soft dry cloth. If the liquid is left on the display it could damage the display.
- Do not close the display when it is in the open position while ejecting a disc or Memory Stick. This could damage the products.
- In order to protect the display from heat and dust, leave the display in the closed position at all times other than when inserting/ejecting discs or Memory Sticks.

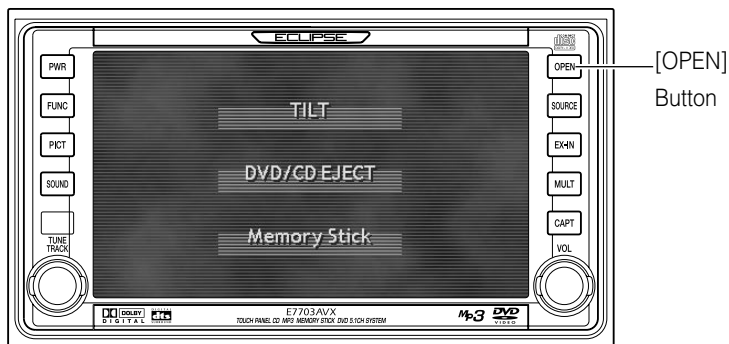

## Adjusting the display angle

The screen viewing angle can be adjusted to any of 6 stepped positions when light from outside the vehicle makes viewing difficult.

### 1 Press the [OPEN] panel button.

The display switches to the Display Open/Tilt selection screen.

### 2 Touch the **TILT** touch switch.

The display will tilt upwards by one step (5°). Each press of the button tilts the panel by another step.

Touching the **TILT** touch switch when the display is at step 6 (30°) will cause the display to return to the original position (0°).



- Even in an adjusted angle position, touching the **DVD/CD EJECT** touch switch or the **Memory Stick** will open the display. When the display closes, it will return to the adjusted angle position.
- If the display is in an adjusted angle position when the vehicle ignition is turned off, the display will automatically return to the original position (0°). If the ignition switch is then turned to ACC or ON, the display will return to the adjusted angle position.



- Be careful not to pinch your hands or other objects when adjusting the angle of the display. This could cause an injury or damage to the display.
- Observe the following cautions when adjusting the angle of the display.
  - <Automatic transmission vehicle>  
When setting the tilt position, choose an angle that does not interfere with operation of the shift lever in the "P", "R" or "N" lever positions. (If there is interference with the shift lever in operating positions, do not set a tilt position.)
  - <Manual transmission vehicle>  
When setting the tilt position, choose an angle that does not interfere with operation of the shift lever in the 1, 3, 5 or "R" lever positions. (If there is interference, do not set a tilt position.)

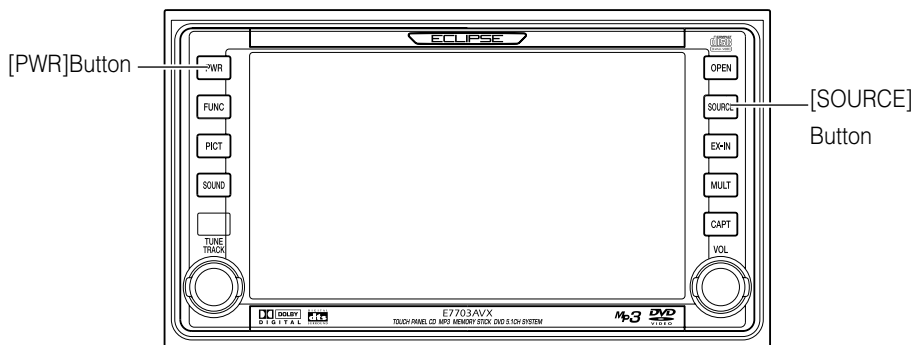

## Turning power on and off

Use the following steps to turn power on or off.

- 1 Press the [PWR] panel button.

The power will be turned on or off each time the button is pressed.

## Switch to other modes

- 1 Press the [SOURCE] panel button.



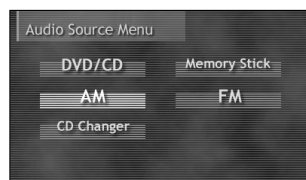

The Audio Source menu screen will appear.



Equipment that is not connected will not be displayed.



## 2 Touch a touch switch for an audio mode.

The operation screen for each audio mode will appear when its button is touched.

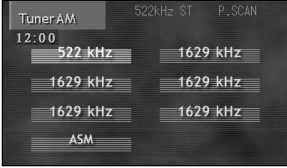
Touch switch	Display Screen	Function
<b>DVD/CD</b>	<b>CD</b> 	<ul style="list-style-type: none"> <li>•Switches to the operation screen for the type of disc inserted and begins playback.</li> <li>•Switches to the video projection screen if a DVD or video CD is inserted.</li> </ul> <p>Touch the display to switch to the operation screen. (Only for DVD video)</p>
	<b>MP3</b> 	
	<b>DVD</b>  ↓ (Touch the display) 	
	<b>Video CD</b> 	

Touch switch	Display Screen	Function
<b>Memory Stick</b>	 <p>The display shows 'Memory Stick' at the top, followed by '7- 0'13' and '4:05'. Below this is 'ECLIPSE SELECTION by FUJITSU TEN' and an 'Edit' button. At the bottom are three buttons: 'SCAN', 'REPEAT', and 'RANDOM'.</p>	Switches to the operation screen if the MG Memory Stick has music data in it and then begins playback.
<b>AM</b>	 <p>The display shows 'Tuner AM' at the top, followed by '522kHz ST' and 'P.SCAN'. Below this is '12:00' and '522 kHz' with a bar graph. To the right is '1629 kHz'. Below are two more rows of '1629 kHz' with bar graphs. At the bottom is an 'ASM' button.</p>	Switches to the operation screen for AM radio and begins receiving radio broadcasts.
<b>FM</b>	 <p>The display shows 'Tuner FM.1' at the top, followed by '87.50MHz ST' and 'P.SCAN'. Below this is '12:00' and '87.50 MHz' with a bar graph. To the right is '105.10 MHz'. Below are two more rows of frequency pairs with bar graphs: '93.10 MHz' and '107.90 MHz', and '98.10 MHz' and '107.90 MHz'. At the bottom is an 'ASM' button.</p>	Switches to the operation screen for FM radio and begins receiving radio broadcasts.
<b>CD Changer</b>	 <p>The display shows 'CD Changer' at the top, followed by '1- 0'47' and 'ECLIPSE SELECTION'. Below this is '12:00' and a grid of buttons for 'Disc 1' through 'Disc 12'. At the bottom are four buttons: 'SCAN', 'REPEAT', 'RANDOM', and 'TITLE'.</p>	Switches to the operation screen for CD auto-changer (sold separately) and begins playback of disc loaded in the CD auto-changer.

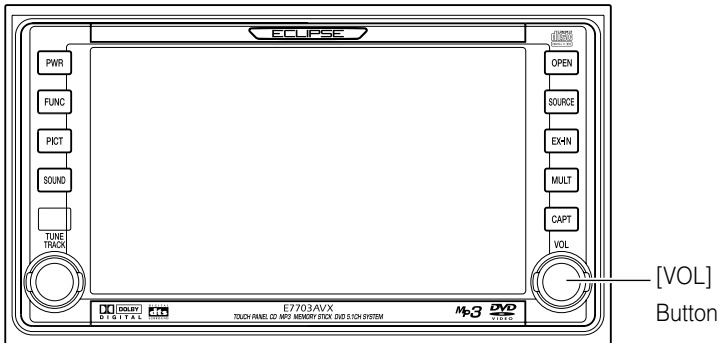

## Adjusting the main volume

- 1 Turn the [VOL] panel button left or right.  
Right: Increases volume.  
Left: Decreases volume.

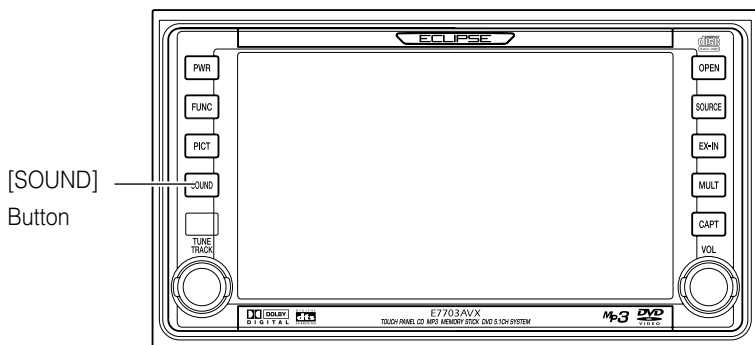

## Displaying the sound adjustment screen

Sound quality can differ greatly from the original recording due to various factors such as the media being played in the vehicle, the type of music selected and the distance from the speakers. This unit allows setting optimum sound quality by making adjustments for each of those factors.

### 1 Press the [SOUND] panel button.

Switches to Sound Adjustment Screen Page 1.

Sound Adjustment Screen Page 1

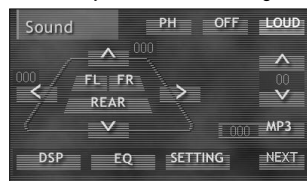

### 2 Touch the **NEXT** touch switch.

Switches to Sound Adjustment Screen Page 2.

Sound Adjustment Screen Page 2

Touching the **RETURN** touch switch will return the display to Sound Adjustment Screen Page 1.



- The touch switches for **DSP**, **EQ** and **SETTING** bring up both Page 1 and Page 2 of the Sound Adjustment screen, and adjustments can be made from either screen.
- Pressing the [SOUND] panel button a second time returns the display to the audio operation screen previously in use.



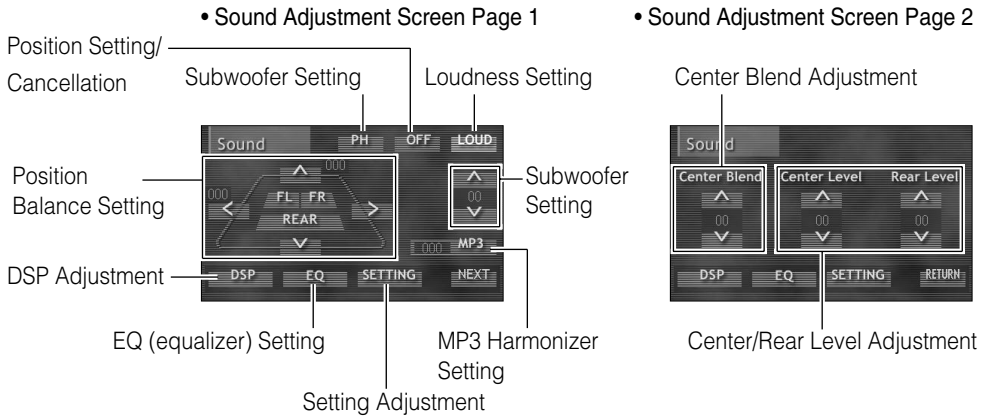

The adjustments shown below are possible in the corresponding Sound Adjustment screen.

Item	Function	Refer to page
Position Balance Setting	Enables switching of stereo positioning to match seating position and number of passengers and also adjusts front/rear and left/right volume balance.	34
Position Setting/Cancellation	Enables cancellation of set position.	34
Loudness Setting	Enables emphasizing low/high sounds at low volume.	35
MP3 Harmonizer Setting	Enables setting of sound correction level for playback at best possible original sound for MP3 compressed music data.	37
Subwoofer Setting	Enables switching of phase when subwoofers are connected and enables adjustment of output.	36
DSP Adjustment	Enables selection and adjustment of preferred DSP levels for previously set DSP modes so they will match each music genre to be played.	38
EQ (equalizer) Setting	Enables selection and adjustment of preferred equalizer curves for previously set equalizer settings so they will match each music genre to be played.	40
Center/Rear Level Adjustment	Enables adjustment of output levels for the center speaker and rear speakers.	45, 46
Center Blend Adjustment	Enables blending of dialog from center speaker with dialog from left/right front speakers when playing a DVD video and enables adjustment of stereo positioning for the center.	45
Setting Adjustment	Enables switching of Dolby Pro Logic, adjustment of compression level, setting of Down Mix, setting of speaker sizes and adjustment of time alignment when playing a DVD video.	47

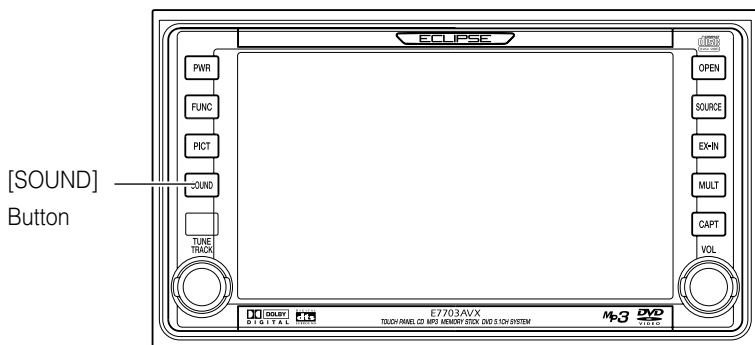

[SOUND]  
Button

## Setting position/volume balance

Setting the position of the listeners will adjust the time of sound delivery from the speakers to the listeners so a more natural stereo positioning is obtained. One method easily switches stereo positioning by touching a seat image. A different method adjusts volume balance to match preferences.



ATTENTION

Position and volume balance cannot be set at the same time.

### 1 Press the [SOUND] panel button.

Switches to Sound Adjustment Screen Page 1.

#### Position setting

### 1 Touch a position (seat) touch switch.

The color of the selected position will change to the selection color.

Touching the button again will cancel the setting.

Touching the **OFF** touch switch will cancel all settings.

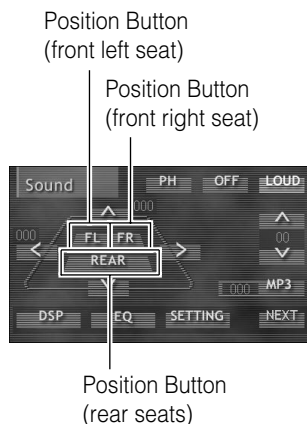

## Volume balance adjustment

Enables adjustment of front/rear (FADER) and right/left (BALANCE) volume balance and enables emphasizing sound from hard to hear speakers.



Volume balance cannot be adjusted when a Position Setting is selected.

- 1** Touch the **▲**, **▼**, **▶** or **◀** touch switch to adjust the volume balance.

The adjustment level can be set to one of 15 levels between front and rear.

- ▲** : Emphasizes front speakers.  
**▼** : Emphasizes rear speakers.

The adjustment level can be set to one of 15 levels between left and right.

- ◀** : Emphasizes left speakers.  
**▶** : Emphasizes right speakers.

FADER (front speakers)

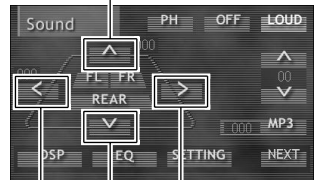

BALANCE  
(right speakers)

FADER (rear speakers)

BALANCE (left speakers)

## Setting loudness

Enables modulation of sound for correction of sensation that low/high sounds are insufficient when listening to audio at reduced volume.

- 1** Press the [SOUND] panel button.

Switches to Sound Adjustment Screen Page 1.

- 2** Touch the **LOUD** touch switch.

Loudness function will switch between on/off each time the **LOUD** touch switch is pressed.

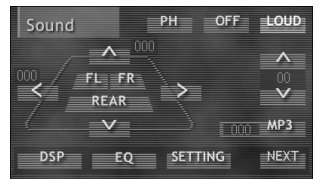

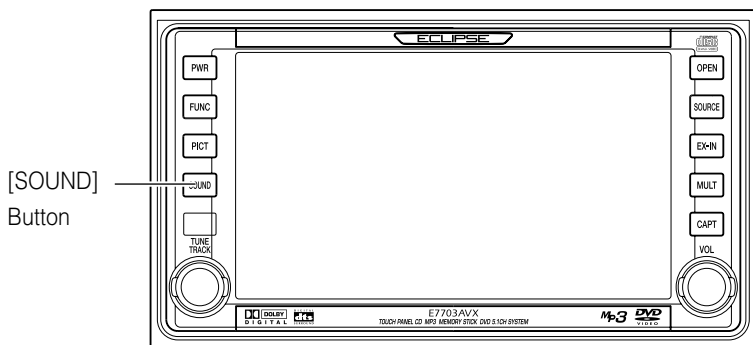

## Setting the subwoofer

This function switches the phase (the output timing) and adjusts the output when a subwoofer is connected.

### 1 Press the [SOUND] panel button.

Switches to Sound Adjustment Screen Page 1.

### Switching phase with (phase control)

Some sounds output from the subwoofer are in the same frequency range as the sounds from the front/rear speakers, and depending on the conditions inside the vehicle, these sounds can cancel each other out. The subwoofer uses phase switching to guard against this phenomenon.

To match the conditions in the vehicle, this function can be set to either "Normal" (subwoofer output timing is the same as the front/rear speakers) or "Reverse" (subwoofer output timing is offset from the front/rear speakers).

### 1 Touch the PH touch switch.

Each time the PH touch switch is pressed the phase will switch between Normal/Reverse. The color of the button will change when Reverse is selected.

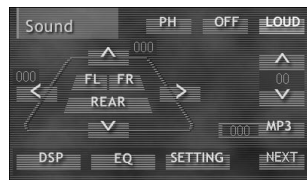

## Subwoofer output adjustment

The output level of the subwoofer can be adjusted.

**1 Touch the  or  touch switch.**

The adjustment level has 10 "+" steps and 10 "-" steps.

 : Increases level.

 : Decreases level.

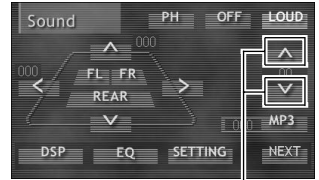

Subwoofer  
Output Level  
Button

## Setting MP3 sound correction (MP3 harmonizer)

When an audio recording is converted to MP3, it is compressed to a sound range that cannot be heard by the average person. The MP3 Harmonizer plays the audio after returning the compressed sound range to the original recording as much as possible, thereby allowing enjoyment of clear, vibrant audio.

**1 Press the [SOUND] panel button.**

Switches to Sound Adjustment Screen Page 1.

**2 Touch the  touch switch.**

Switches to Hi → Lo → OFF each time the  touch switch is pressed.

Hi : Raises correction level.

Lo : Lowers correction level.

OFF : No correction.

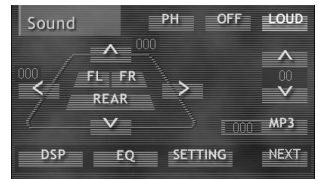

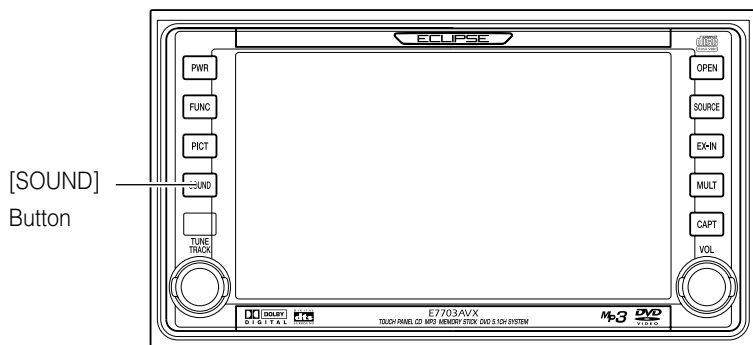

## Setting DSP

The DSP function reproduces the sensation of various factory set performance environments by adding reverberation to the music being played.



ATTENTION

- DSP cannot be used when playing DVD video with Dolby Digital (5.1 ch) or DTS (5.1 ch).
- DSP cannot be used when playing DVD video if Dolby Pro Logic is set to "AUTO" or "ON".  
To use DSP, switch the Dolby Pro Logic setting to "OFF". (Refer to "Dolby Pro Logic setting " page 49.)

1

Press the [SOUND] panel button.

Switches to Sound Adjustment Screen  
Page 1.

2

Touch the **DSP** touch switch.

Switches to DSP Setting Screen.

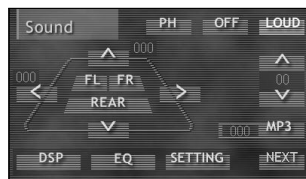

ATTENTION

The DSP Setting Screen can also be accessed from Sound Adjustment Screen Page 2.

## DSP mode setting

### 1 Touch one of the DSP mode touch switches.

Switches the display to the corresponding DSP mode as shown in the table below.



Switch	DSP Environment	Switch	DSP Environment
<b>Concert</b>	Concert hall	<b>Stadium</b>	Outdoor stadium
<b>Live</b>	Live performance arena	<b>Club</b>	Disco, Club
<b>Cathedral</b>	Church with echo	<b>DEFEAT</b>	DSP OFF

### 2 Touch the **ESC** touch switch.

Returns to Sound Adjustment Screen Page 1.

## DSP adjustment, saving

Adjusts the factory set individual DSP modes (environments) to preferred levels and saves the settings.

### 1 In DSP mode, touch the **▲** or **▼** touch switch.

The adjustment level has 5 "+" steps and 5 "-" steps.

**▲** : Increases level.

**▼** : Decreases level.



### 2 Touch a switch from **ch1** to **ch6** until a beep is heard.

Saves the adjusted DSP mode in memory.



The adjusted level for a DSP mode (environment) will not be saved if the unit is switched to another DSP mode before saving.

### 3 Touch the **ESC** touch switch.

Returns to Sound Adjustment Screen Page 1.

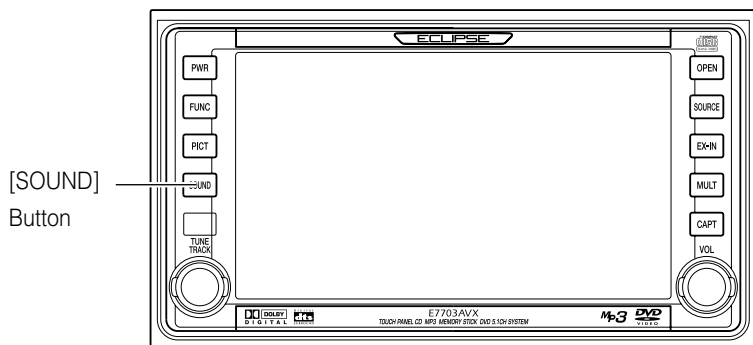

### Saved DSP mode display

Displays the saved DSP mode for touch switches **ch1** to **ch6**.

- 1 Touch a touch switch from **ch1** to **ch6** briefly (less than 1 second).
- 2 Touch the **ESC** touch switch.

Returns to Sound Adjustment Screen Page 1.



## Setting EQ (Equalizer)

Adjusts sound qualities to preferred characteristics according to the music genre and audio source.

Equalizer settings for front, rear and center speakers can be made separately.

- 1 Press the [SOUND] panel button.

Switches to Sound Adjustment Screen Page 1.

- 2 Touch the **EQ** touch switch.

Switches to the Equalizer Setting Screen.

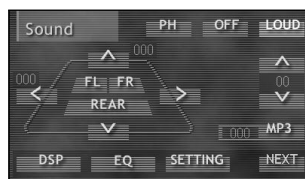

The Equalizer Setting Screen can also be accessed from Sound Adjustment Screen Page 2.



## Equalizer mode setting

Adjusts the factory set individual equalizer modes to preferred levels and saves the settings.



Front, rear and center settings cannot be made at the same time. Make settings according to the listening position.

- 1 Touch the **Front** , **Rear** or **Center** touch switch.
- 2 Touch the touch switch for each equalizer mode.

Switches the display to the corresponding equalizer mode as shown in the table below.

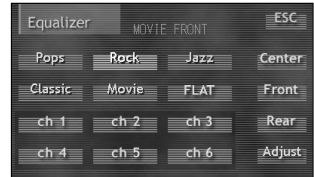

Switch	Equalizer Mode	Switch	Equalizer Mode
<b>Pops</b>	Pop	<b>Classic</b>	Classical
<b>Rock</b>	Rock	<b>Movie</b>	Film
<b>Jazz</b>	Jazz	<b>FLAT</b>	No Correction

- 3 Touch the **ESC** touch switch.  
Returns to Sound Adjustment Screen Page 1.

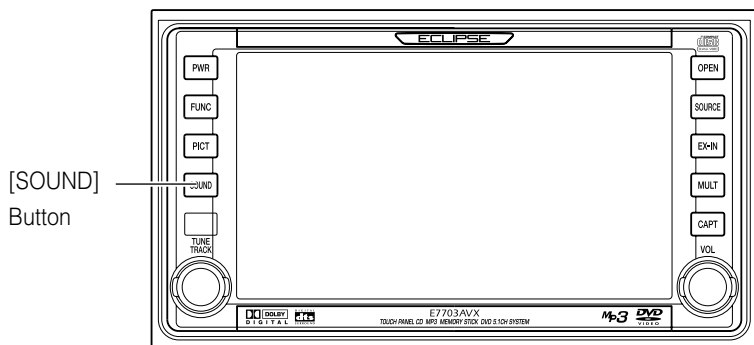

[SOUND]  
Button

## Equalizer curve adjustment, saving

Adjusts the factory set individual equalizer curves to preferred forms and saves the settings.



Front, rear and center settings cannot be made at the same time.

- 1 Touch the **Front** , **Rear** or **Center** touch switch.
- 2 Touch the **Adjust** touch switch.  
Switches to Equalizer Adjustment Screen.
- 3 Touch the screen with a finger to draw the preferred equalizer curve image.
- 4 For exact adjustments, touch the frequency bar to be adjusted or the **Freq** touch switch, and then touch **▲** or **▼** .

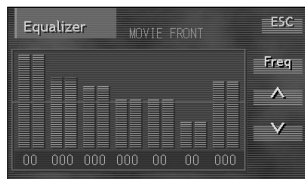
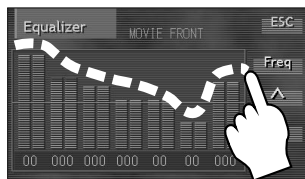
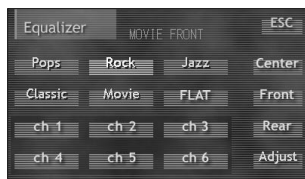

- 5 Touch the **ESC** touch switch.**  
Switches to Equalizer Setting Screen.
- 6 Touch a switch from **ch1** to **ch6** until a beep is heard.**  
Saves the adjusted equalizer curve in memory.
- 7 Touch the **ESC** touch switch.**  
Returns to Sound Adjustment Screen Page 1.

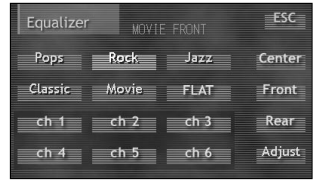

### Saved equalizer mode display

Displays the saved equalizer modes for touch switch **ch1** to **ch6**.

- 1 In Equalizer mode, touch either the **ch1** or **ch6** button.**  
Displays the saved equalizer curve.
- 2 Touch the **ESC** touch switch.**  
Returns to Sound Adjustment Screen Page 1.

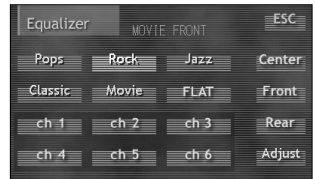

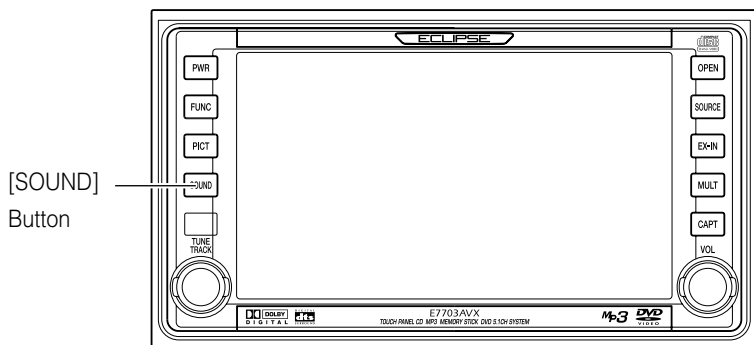

## Adjusting the surround system

This audio equipment supports Dolby Digital (5.1 ch), DTS (5.1 ch), LPCM, SDDS and Dolby Pro Logic. This enables enjoyment of rich theater sound, even in a limited space, when playing a video that has been recorded with one of these technologies.

ch (channels)...number of audio output sources that can be simultaneously played.



ATTENTION

Center speaker with power amplifier and subwoofer with power amplifier (sold separately) are required for playing audio sound with Dolby Digital (5.1 ch) or DTS (5.1 ch).

### 1 Press the [SOUND] panel button.

Switches to Sound Adjustment Screen Page 1.

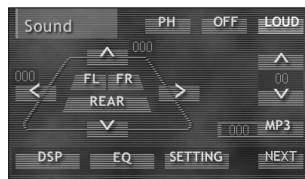

### 2 Touch the **NEXT** touch switch.

Switches to Sound Adjustment Screen Page 2.



## Center blend adjustment

Blends dialog from center speaker with dialog from front speakers (left and right) when a DVD video with Dolby Digital (5.1 ch) or DTS (5.1 ch) is played and adjusts stereo positioning for the center.



Center Blend cannot be adjusted if Dolby Pro Logic is set to "OFF". Switch Dolby Pro Logic to "ON" to make adjustments. (Refer to "Dolby Pro Logic setting," page 49.)

### 1 Touch the or touch switch.

The adjustment level has 5 "+" steps and 5 "-" steps.

 : Increases output level.

 : Decreases output level.

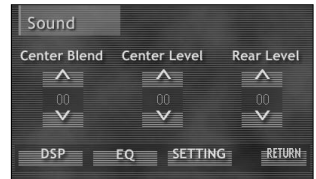



## Center level adjustment

Adjusts the dialog and music output level heard from the center speaker when playing a DVD with Dolby Digital (5.1 ch) or DTS (5.1 ch) or playing a music CD so that the dialog or voice will be easier to hear.

### 1 Touch the or touch switch.

The adjustment level has 10 "+" steps and 10 "-" steps.

 : Increases output level.

 : Decreases output level.

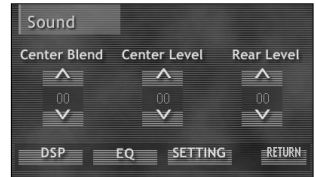

## Rear level adjustment

Adjusts the output level of sound effects and music heard from the rear speaker when playing a DVD with Dolby Digital (5.1 ch) or DTS (5.1 ch) or playing a music CD.

**1 Touch the ▲ or ▼ touch switch.**

The adjustment level has 10 "+" steps and 10 "-" steps.

▲ : Increases output level.

▼ : Decreases output level.

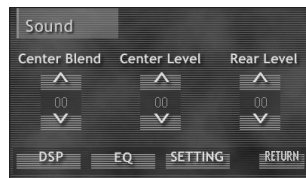

## Compression adjustment

Adjusts the sound sensation range (difference between maximum and minimum) when playing a DVD with Dolby Digital (5.1 ch) or DTS (5.1 ch).

Adjusts the sound sensation range (difference between maximum and minimum) when playing a DVD with Dolby Digital (5.1 ch). Raising the numerical value of the Compression level will narrow the sound range so that dialog and voices will be easier to hear even when background sounds are intense.

### 1 Touch the **SETTING** touch switch.

Switches to Setting Screen.

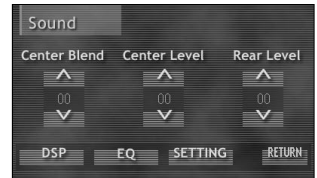

- The Setting Screen can also be accessed from Sound Adjustment Screen Page 1.
- Compression cannot be adjusted if "Woofer" is set to "NO" at the Speaker Size Setting Screen. Adjust Compression after switching "Woofer" to "YES". (Refer to "Setting speaker size," page 50)

### 2 Touch the **▲** or **▼** touch switch.

Adjustment levels are "OFF", "MID" and "FULL".

**▲** : Touch and hold to increase level, reach FULL.

**▼** : Touch and hold to decrease level, reach OFF.



Adjustment Level	Function
OFF	Compression function effect is off.
MID	Compression function effect can be adjusted in a middle range.
FULL	Compression function effect is at maximum.

### 3 Touch the **ESC** touch switch.

Returns to Sound Adjustment Screen Page 1.

## Down mix setting

If your vehicle is not equipped with a center speaker, the Down Mix function allows you to enjoy the sound of DVD video with Dolby Digital (5.1 ch) or DTS (5.1 ch).

- 1 Touch the **SETTING** touch switch.  
Switches to Setting Screen.

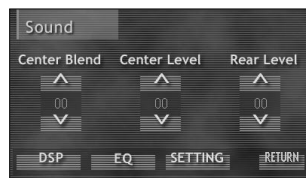

The Setting Screen can also be accessed from Sound Adjustment Screen Page 1.

- 2 Touch the **DOWN MIX** touch switch.  
Switches items in the following order each time the **DOWN MIX** switch is touched.

Lt/Rt → STEREO → OFF



Setting items and functions are shown below.

Item	Function
Lt/Rt	Dialog and voices heard from the center speaker are divided and output from the front left and right speakers as well. If this setting is not made for a 2-speaker system, the dialog and voices will not be heard.
STEREO	Dialog and voices heard from the center speaker are divided and output from the front rear and rear speakers as well. This is most appropriate for 4-speaker systems.
OFF	Down Mix function is off.

- 3 Touch the **ESC** touch switch.  
Returns to Sound Adjustment Screen Page 1.



## Dolby Pro Logic setting

Switches ON or OFF Dolby Pro Logic when playing a DVD with Dolby Pro Logic.

- 1 Touch the **SETTING** touch switch.  
Switches to Setting Screen.

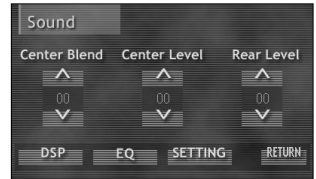

The Setting Screen can also be accessed from Sound Adjustment Screen Page 1.

- 2 Touch the **Dolby PL** touch switch.  
Switches to item in the following order each time the **Dolby PL** switch is touched.

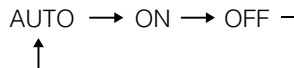

Setting items and functions are shown below.

Item	Function
AUTO	Switches to ON only when playing a DVD video recorded with Dolby Pro Logic and stays OFF at all other times.
ON	Remains ON for playing of DVD videos recorded with 2 channels.
OFF	The Dolby Pro Logic function remains OFF.

- 3 Touch the **ESC** touch switch.  
Returns to Sound Adjustment Screen Page 1.

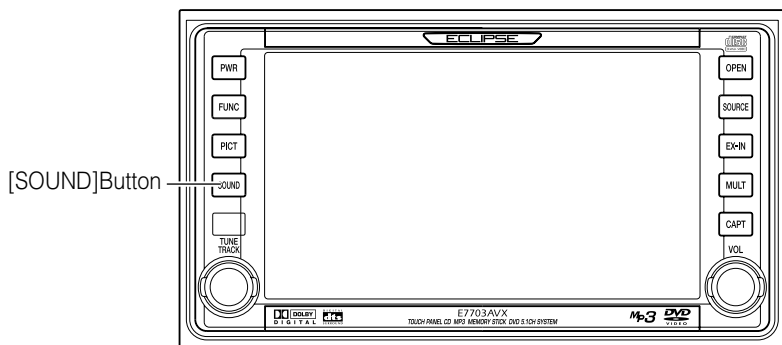

## Setting speaker size

Enables matching of system to availability and size (range) of speakers mounted in the vehicle and optimizes output channels and ranges for playing of DVD video supporting Dolby Digital (5.1 ch), Dolby Pro Logic or DTS (5.1 ch).



- Be sure to set the speaker sizes and woofer availability for playing DVD video. If the speakers of the vehicle are not matched to the system, the dialog and special effects audio of the video may not be output.
- Speaker size can be adjusted while playing a DVD video with Dolby Digital (5.1 ch), Dolby Pro Logic or DTS (5.1 ch). The speaker size function does not operate with other types of DVD video even if it is switched on.

### 1 Press the [SOUND] panel button.

Switches to Sound Adjustment Screen Page 1.

### 2 Touch the **SETTING** touch switch.

Returns to Setting Screen.

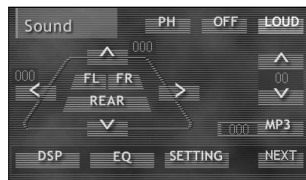

The Setting Screen can also be accessed from Sound Adjustment Screen Page 2.

**3** Touch the **Speaker** touch switch.

Switches to Speaker Size Setting Screen.

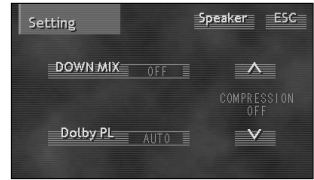

**4** Touch the **Center**, **Rear** or **Woofers** switch and select speaker size and woofer availability.

Switches items in the following order each time any of the above buttons is touched.

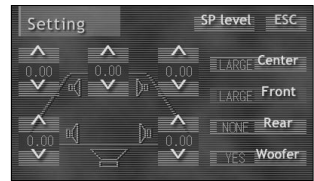

Switch	Speaker Size Switching
<b>Center</b>	LARGE → SMALL → NONE
<b>Rear</b>	
<b>Woofers</b>	YES ↔ NO



ATTENTION

- Front is always set to "LARGE".
- It is recommended that "LARGE" be set for speakers capable of playing low ranges of 100Hz or lower and "SMALL" be set for speakers not capable of playing low ranges of 100Hz or lower.
- When no front center speaker is connected, DVD video with 5.1 channels can be enjoyed by setting Center to "NONE".
- DVD videos recorded with monaural are only output from the center speaker. By setting Center to "NONE", the sound will be divided and output from the left and right front speakers even though the center speaker is connected.

**5** Touch the **ESC** touch switch.

Returns to Setting Screen.

**6** Touch the **ESC** touch switch.

Returns to Sound Adjustment Screen Page 1.

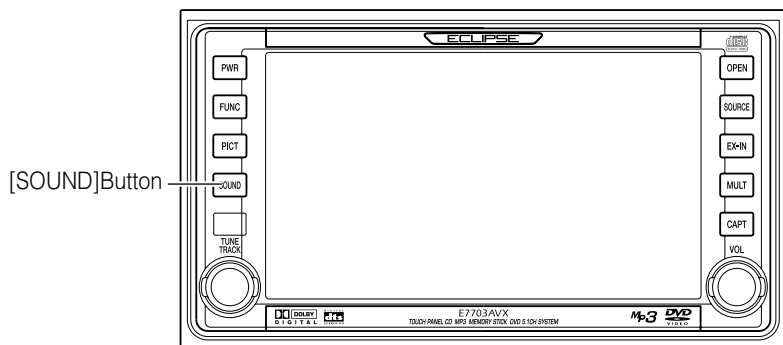

## Setting time alignment/output level

By adjusting the distance of the listener position from the speakers and the output level of each speaker, the difference of sound arrival times for the different distances can be corrected.



ATTENTION

If a speaker is not connected or if "NONE", "NO", "Center", "Rear" or "Woofer" is set for the size of the speaker, the numerical values will not be effective even though adjustments have been made for distances to the listener position and for speaker output levels.

### 1 Press the [SOUND] panel button.

Switches to Sound Adjustment Screen Page 1.

### 2 Touch the **SETTING** touch switch.

Switches to Setting Screen.

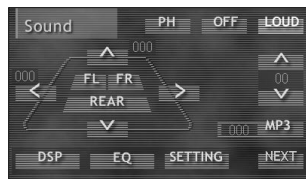

ATTENTION

The Setting Screen can also be accessed from Sound Adjustment Screen Page 2.

### 3 Touch the **Speaker** touch switch.

Switches to Speaker Size Adjustment Screen.



## Distance setting

- 1 Touch the **▲** or **▼** touch switch and set the distance from each speaker to the listener position.

**▲**: Increases numerical value.

**▼**: Decreases numerical value.

Setting range is 0~4 m in steps of 0.05 m. As the numerical value for distance becomes smaller, delay of sound from the speaker to the listener becomes larger.

- 2 Touch the **ESC** touch switch.

Returns to Setting Screen.

- 3 Touch the **ESC** touch switch.

Returns to Sound Adjustment Screen  
Page 1.

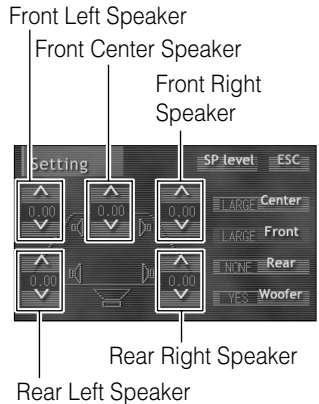

## Output level adjustment



If POSITION is set to "ON", speaker levels cannot be adjusted except for the woofer. Make settings after switching POSITION to "OFF". (Refer to "Position setting," page 34.)

- 1 At the Speaker Setting Screen, touch the **SP level** touch switch.

Switches to Speaker Level Adjustment Screen.

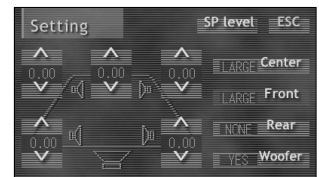

- 2 Touch the ▲ or ▼ touch switch and set output levels so that they sound to be at the same volume from each speaker.**

▲ : Increases output level.

▼ : Decreases output level.

Setting range is -6~+6dB.

As the numerical value for the level becomes smaller, the sound output from the speaker becomes smaller.

- 3 Touch the ESC touch switch.**

Returns to Setting Screen.

- 4 Touch the ESC touch switch.**

Returns to Sound Adjustment Screen  
Page 1.

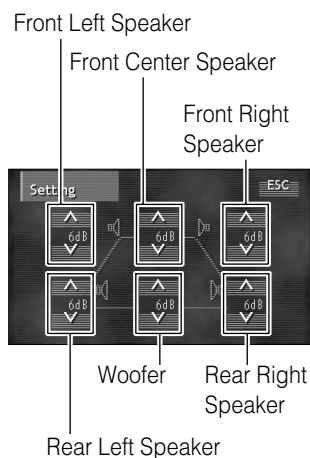

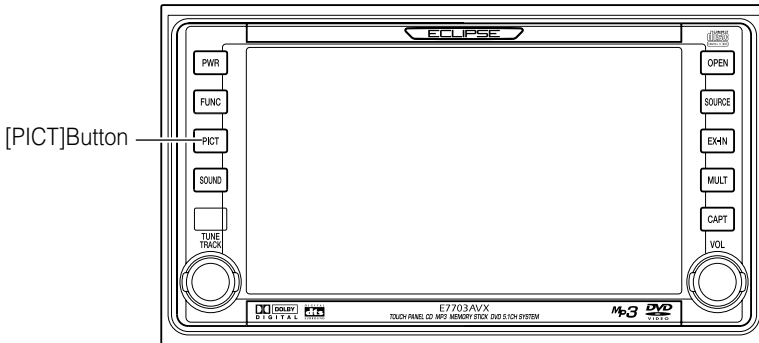

[PICT]Button

## Adjusting image quality

Contrast, brightness and other picture settings can be adjusted to match preferences for viewing DVD video or the audio operation screen.

To make viewing easier, the display switches between day screen/night screen according to whether the vehicle lights (parking lights, taillights, license plate lights) are on/off.

### 1 Press the [PICT] panel button.

Switches to Audio Screen Adjustment Mode.

Pressing the [PICT] button again will cancel Audio Screen Adjustment Mode.

### Audio operation screen image adjustment

#### 1 Touch the ▲ or ▼ touch switch.

The adjustment level has 5 "+" steps and 5 "-" steps.

<Contrast Adjustment>

▲ : Increases contrast.

▼ : Decreases contrast.

<Brightness Adjustment>

▲ : Makes brighter.

▼ : Makes darker.

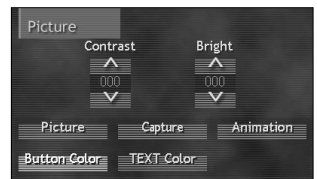

## DVD, VTR image adjustment

### 1 Touch the **▲** or **▼** touch switch and adjust image quality.

The adjustment level has 5 "+" steps and 5 "-" steps.

<Contrast>

**▲** : Increases contrast.

**▼** : Decreases contrast.

<Bright>

**▲** : Makes brighter.

**▼** : Makes darker.

<Tint>

**▲** : Increases green colors.

**▼** : Increases red colors.



<Color>

**▲** : Makes color darker.

**▼** : Makes color lighter.



Settings for the day screen and night screen can be made independently.



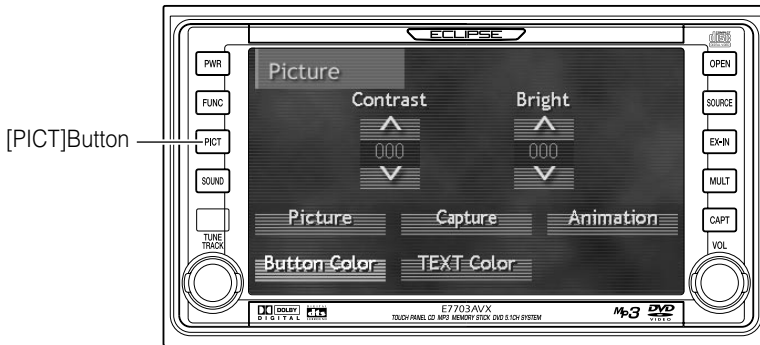

[PICT]Button

## Switching screen background

This unit allows selection and display of different backgrounds for the Audio Operation Screen.

Item	Function
Background Screen	Allows selection and display of a factory-prepared background (2 types).
Captured Screen	Allows selection and display of an image captured from DVD video, navigation or external camera or display of an image saved on a CD-R or Memory Stick. For details on capturing and saving video images refer to "Capturing images," page 64, and for details on saving image data files refer to "Saving and exporting image data," page 60.
Animation	Allows selection and display of a factory-prepared video (6 types).

### 1 Press the [PICT] panel button.

Switches to Audio Screen Adjustment Mode.

Pressing the [PICT] button again will cancel Audio Screen Adjustment Mode.

## Background screen display

- 1 **Touch the **Picture** touch switch.**  
Switches backgrounds in the following order each time the **Picture** switch is touched.

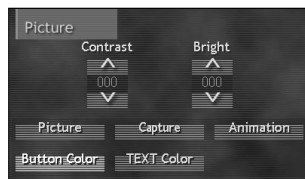

Background 1 (solid blue) ↔ Background 2 (gradation)

## Captured image display

- 1 **Touch the **Capture** touch switch.**  
Switches saved images (6 maximum) in order each time the **Capture** button is touched.

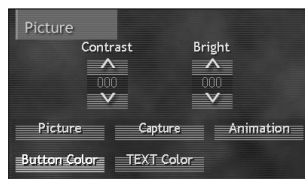

## Video display

- 1 **Touch the **Animation** touch switch.**  
Switches between 6 videos in order each time the **Animation** switch is touched.

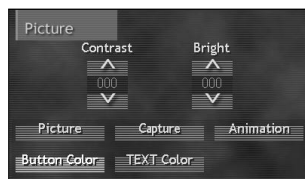

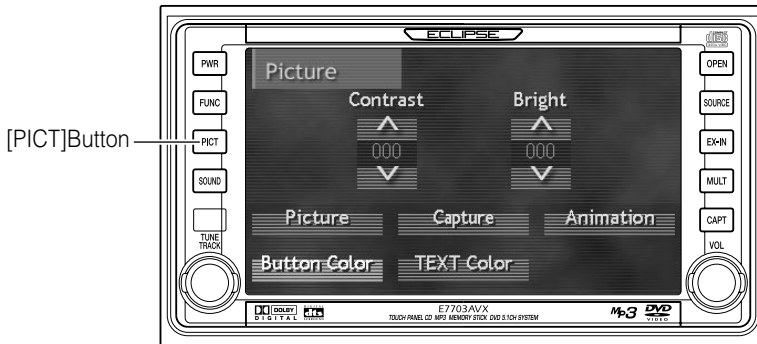

## Changing the touch switch display

The display color and text color for the touch switches can be changed.

### 1 Press the [PICT] panel button.

The mode will change to audio screen adjustment mode.

If you press the [PICT] panel button once more, audio screen adjustment mode will be exited.

### Changing the touch switch display color

#### 1 Touch the **Button Color** touch switch.

The button background color will change as follows each time you touch the **Button Color** touch switch.

□ Aqua → Green → Red → Purple □

### Changing the text display color

#### 1 Touch the **TEXT Color** touch switch.

The color for text such as frequency, elapsed time and level displays will change as follows each time you touch the **TEXT Color** touch switch.

□ Green → Orange → White → Aqua □

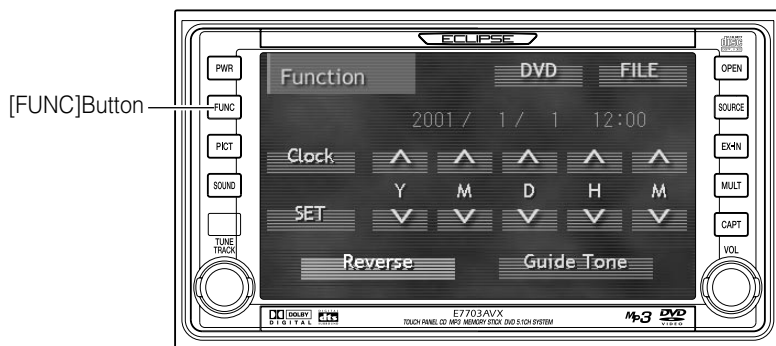

## Saving and exporting image data

The unit can save up to a maximum of six image files using image data that has been saved onto CD-Rs, MG Memory Sticks and Memory Sticks, and also images that are stored on DVDs or that have been captured using a back-eye camera or other multi-purpose external camera. These images can then be used as background images for the audio operation screen. In addition, the saved image data can also be saved to an MG Memory Stick or Memory Stick.

- 1 Insert the CD-R or Memory Stick containing the images to be saved, or insert the Memory Stick that is to be used for saving the images.
- 2 Press the [FUNC] panel button.  
The mode will change to function mode.  
If you press the [FUNC] button once more, function mode will be exited.
- 3 Touch the **FILE** touch switch.

The display will change to the menu screen for file management mode.

## Saving image data

- 1 If reading images from a CD-R, touch the **Read (CD-R)** touch switch. If reading images from a Memory Stick, touch the **Read (Memory Stick)** touch switch.**

The file reading screen will then be displayed.

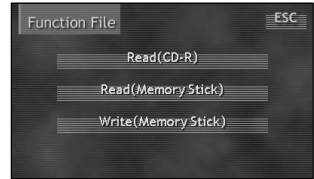

- 2 Touch the image file to be read and saved.**

The image for the selected file will be displayed.

If there are more than six files on the media, touch **▲** or **▼** to search through the list of image files for the files you would like to read and save.

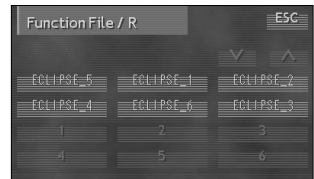

- 3 Touch (2 seconds or more) one of the touch switches from **1** to **6**.**

The image file that was selected in step **2** above will then be saved.

If an image file has already been saved, it will be overwritten.



Images cannot be read from Memory Sticks while MP3 files are being played.

- 4 Touch the **ESC** touch switch.**

The display will return to the menu screen for file management mode.

- 5 Touch the **ESC** touch switch.**

The display will return to the initial function mode screen.



Saved images that are used as background images for the audio operation screen must conform to the file specifications that are given below. If you read and save files that do not conform to these specifications, the list display may not be displayed or the file names may not appear correctly. Bitmap files and JPEG files that you have created yourself may not display correctly depending on the tools that were used to create them.

[For CD-Rs]

- Disc format: ISO9660 standard
- Image size (per file): Up to 512 KB
- Displayed file name: ISO9660 Level 1 format
- File extension: .jpg (JPEG2000 is not compatible) or .bmp
- Write format: Single session only
- Display file no.: Up to 100
- Image size: 400 (W) x 240 (H) dots or less
- No. of display characters: Up to 8 single-byte characters (+ .jpg or +.bmp)
- Displayed files: Root directory only

[For Memory Sticks]

- Image size (per file): Up to 512 KB
- Displayed file name: ISO9660 Level 1 format
- File extension: .jpg (JPEG2000 is not compatible) or .bmp
- Display file no.: Up to 100
- Image size: 400 (W) x 240 (H) dots or less
- No. of display characters: Up to 8 single-byte characters (+ .jpg or +.bmp)
- Displayed files: Root directory, and also folder hierarchies as shown in the example below. (For JPEG files, the files cannot be read unless the folder hierarchy is created as shown in the example below.)

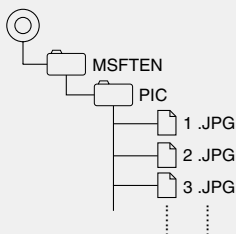

- If the image size exceeds the recommended size, it will not be possible to display or read the file.
- If the image size is smaller than the recommended size, the image will be centered horizontally and vertically middle of display).
- Only six images can be read and saved.

## Saving images to a Memory Stick

**1 Touch the **Write (Memory Stick)** touch switch.**

The file exporting screen will be displayed.

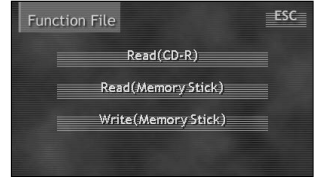

**2 Touch one of the touch switches from **1** to **6**.**

The image file that has been saved for that touch switch will then be saved onto the Memory Stick.



ATTENTION

- Do not turn off the power or turn off the engine switch while a file is being saved onto a Memory Stick, otherwise the file data may become corrupted.
- Images captured from a DVD and video CD cannot be saved onto a Memory Stick.
- The format for files that are saved onto a Memory Stick is bitmap (BMP). Files cannot be saved as JPEG images.

**3 Touch the **ESC** touch switch.**

The display will return to the menu screen for file management mode.

**4 Touch the **ESC** touch switch.**

The display will return to the initial function mode screen.

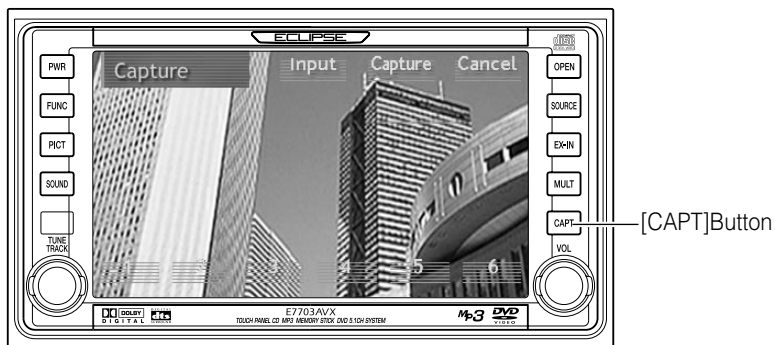

## Capturing images

The unit can capture images from DVD, video CD and multipurpose cameras and also navigation screens, and save them as image files. In addition, these images can then be used as background images for the audio operation screen. Refer to "How to operate the DVD player" (page 95), "How to operate the video CD player" (page 119) for details on DVD and video CD operations.

### 1 Press the [CAPT] panel button.

The mode will change to image capture mode.

Video images will change to frame playback mode.

If you press the [CAPT] button in the panel switches once more, image capture mode will be exited.



- Capturing images when video images are not being played back or of the navigation system is being used or an external camera is connected, you can switch between the navigation screen and images from the external camera by touching **Input** on the touch screen.
- Only images output from multipurpose cameras and navigation systems adopting NTSC (3.58MHz) methods are compatible with this unit. (This unit does not support any other methods.)



## 2 Touch the **Capture** touch switch.

The image being displayed when you touched **Capture** will then be captured and displayed as a still image.

If you touch the **Cancel** touch switch, the image capture will be canceled and you can redo it.



ATTENTION

- When capturing video images, the captured image will be slightly more elongated in height than the original image.
- When capturing video images, the screen will appear momentarily as a blue background until the capturing operation is completed.
- Video images will be captured in wide size.

## 3 Touch (2 seconds or more) one of the touch switches from **1** to **6**.

The captured image file will then be saved.

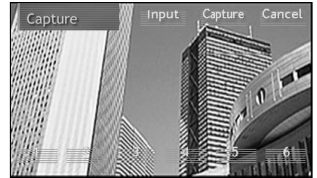

ATTENTION

If an image file has already been saved, it will be over written.

## 4 Touch one of the touch switches from **1** to **6** briefly (less than 1 second).

You can then check the image that has been captured.

## 5 Touch the **Input** touch switch.

The mode will return to image capture mode.



ATTENTION

If no operation is carried out for 6 seconds, the display will return to the image capture mode screen.

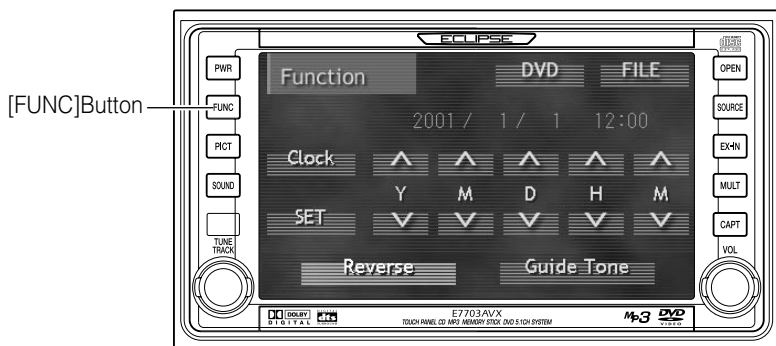

## Changing the clock settings

- 1 Press the [FUNC] panel button.

The mode will change to function mode.

If you press the [FUNC] button once more, function mode will be exited.

### Setting the clock display

This turns the clock display on or off.

- 1 Touch the **Clock** touch switch.

The clock display turns on and off each time the **Clock** switch is touched.

When the clock display is on, the touch switch display color changes to the selected color.

### Adjusting the date and time

This adjusts the date and time.

- 1 Touch the **▲** or **▼** touch switches to adjust each item.



To set the clock to 0 minutes (an exact hour), touch the **SET** touch switch.

For example:

At 3:29: Touch the **SET** touch switch returns to 3:00.

At 3:30: Touch the **SET** touch switch advance to 4:00.

## Setting guide tones

You can turn guide tones on and off.

At the time of purchase, the unit is set so that a beep sounds as a guide tone when an operation is carried out.

### 1 Press the [FUNC] panel button.

The mode will change to function mode.

If you press the [FUNC] button once more, function mode will be exited.

### 2 Touch the **Guide Tone** touch switch.

The guide tones are turned on and off each time the **Guide Tone** touch switch is touched.

When the guide tones are turned off, the touch switch display color changes to the selected color.

## Setting the reverse linking function for the back-eye camera

Back-eye cameras other than ECLIPSE products are connected to the CAPTURE IN terminal, the camera images from the rear of the vehicle can be automatically displayed on the unit's monitor screen when the vehicle's transmission is placed into reverse. This function for displaying images in this way can be turned on and off.

### 1 Press the [FUNC] panel button.

The mode will change to function mode.

If you press the [FUNC] button once more, function mode will be exited.

### 2 Touch the **Reverse** touch switch.

The reverse linking function is turned on and off each time the **Reverse** touch switch is touched.

When the reverse linking function is turned on, the touch switch display color changes to the selected color.

# How to operate the tuner

The unit has four built-in radio bands: AM1, AM2, FM1 and FM2. You can preset up to six channels for each band.

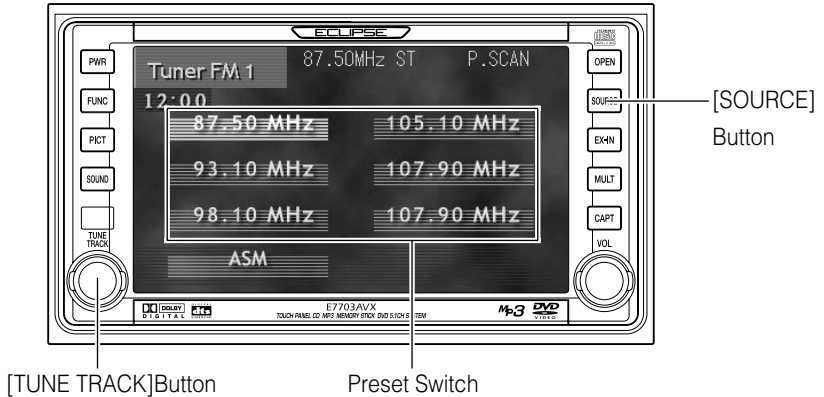

## Listening to the tuner

- 1** Press the [SOURCE] panel button.  
The display will change to the audio source menu screen.
- 2** Touch the **AM** or **FM** touch switch to select the band.



To change to AM1, AM2, FM1 or FM2, change back to the audio source menu screen and touch **AM** or **FM** again.

## Selecting a broadcast station

### Manual selection

- 1** Turn the [TUNE TRACK] panel button briefly (less than 1 second).  
The frequency changes by a single step each time the button is turned.  
(1 step is 9 kHz (for AM) and 0.05 MHz (for FM).)  
Turn right: The frequency becomes higher.  
Turn left: The frequency becomes lower.

## Automatic selection

### 1 Turn the [TUNE TRACK] panel button until a beep is heard.

The station that is closest in frequency to the frequency that is currently displayed on the screen will be searched for automatically, and searching will stop when the station is received. To stop the search before a station is found, turn the [TUNE TRACK] button again.

Turn right: The frequency becomes higher.

Turn left: The frequency becomes lower.



If the reception for a particular station is weak in the area you are in, automatic selection may not work.

## Selection using preset switches

### 1 Touch the preset switch that already has a station recorded.

## Presetting stations automatically

Touch the **FM** or **AM** touch switch and select an FM or AM broadcast.

### 1 Touch (2 seconds or more) the **ASM** touch switch.

The "ASM" display will flash and the station being received will be stored automatically in a preset switch.



- ASM is an abbreviation for Auto Station Memory.
- If less than six stations have been set, the preset switches that have no stations set for them will be unchanged.
- If the power supply from the vehicle's battery is disconnected from the unit as a result of vehicle maintenance or because the unit has been removed from the vehicle, the stations recorded in the preset switches will be cleared. If this happens, you will need to reset the stations.

## Presetting stations manually

Touch the **FM** or **AM** touch switch and select an FM or AM broadcast.

- 1 Turn the [TUNE TRACK] panel button to select the frequency to be preset.
- 2 Touch (2 seconds or more) a preset switch.

The selected frequency will be set for that preset switch, and the frequency will be displayed on the screen.

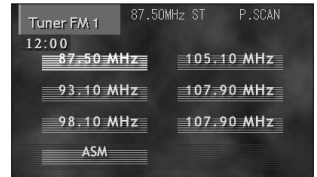

ATTENTION

If the power supply from the vehicle's battery is disconnected from the unit as a result of vehicle maintenance or because the unit has been removed from the vehicle, the stations recorded in the preset switches will be cleared. If this happens, you will need to reset the stations.

## Checking preset stations

This recalls all the stations that have been preset either automatically or manually and plays them each for 5 seconds.

- 1 Touch the **ASM** touch switch briefly (less than 1 second).

"P.SCAN" will be displayed, and the preset stations will each be played back for 5 seconds.

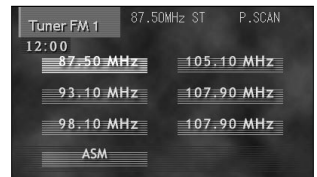

- 2 Touch **ASM** touch switch briefly (less than 1 second) once more.

The station that was being played when the switch was touched will then be played continuously.

## FM reception characteristics

In general, FM has much better tonal quality than AM. However, FM and FM stereo reception encounter several characteristic problems not encountered with AM. FM is more difficult to receive than AM in a moving vehicle. The following are explanatory notes on what to expect from FM reception and on how to get satisfactory performance.

### FM RECEPTION DIFFERS FROM AM

A characteristic of transmitted signals is that lower frequencies travel further. FM frequencies are much higher than AM's (similar to a ray of light): they won't bend but they will reflect. Often, they will be interrupted by tall buildings, mountains, etc., taking direct and indirect paths to your vehicle's antenna. The distance at which FM stations can be received satisfactorily is usually not nearly as far as that which AM stations can be received.

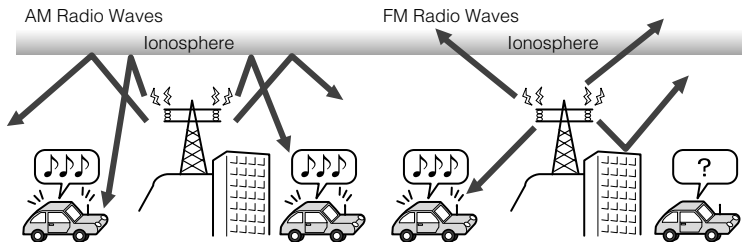

### FADING OUT

In weak signal or "fringe" reception areas, FM stations may fade out completely, or fade in and out. When driving in weak signal areas, such as near hills, through valleys or tunnels, among tall buildings, etc., you may encounter unusual noise interference. **THIS IS NOT A TUNER PROBLEM.** In this case, you can only wait until you are in a better reception area, tune to a stronger station, or reduce the treble level.

## RECEPTION AREA OF FM BROADCASTS

A home receiver can catch weak FM stereo signals through the use of a tall, directional or ultra-sensitive antenna. In a moving vehicle, the area for good reception is limited because of varying conditions encountered while driving, including the types and heights of broadcast antenna structures, signal strength, engine noise, etc. For best reception with manual antenna, extend the antenna mast as far as possible.

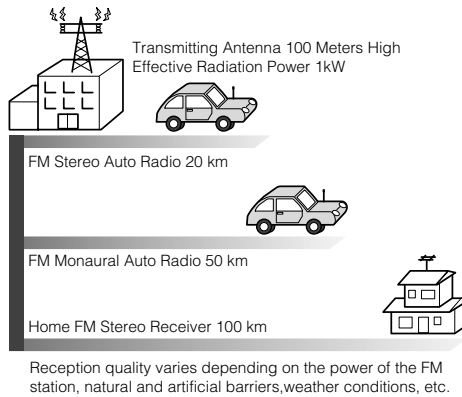

## MULTIPATH

The reflection characteristics of FM waves cause another problem called multipath—FM wave signals reflecting off of buildings, mountains, etc. When the antenna receives direct and reflected waves at the same time, distortion of sound in the treble range often occurs, such as static or harsh-sounding voices. THIS IS NOT A TUNER PROBLEM. Only moving to another area with a clearer signal path can remedy the situation.

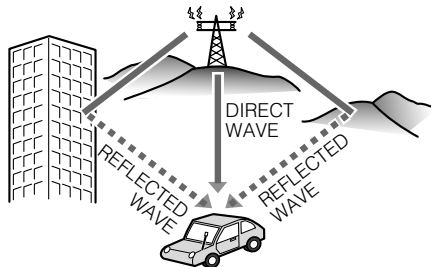



# How to operate the CD player

It is assumed here that a CD has already been loaded into the unit.

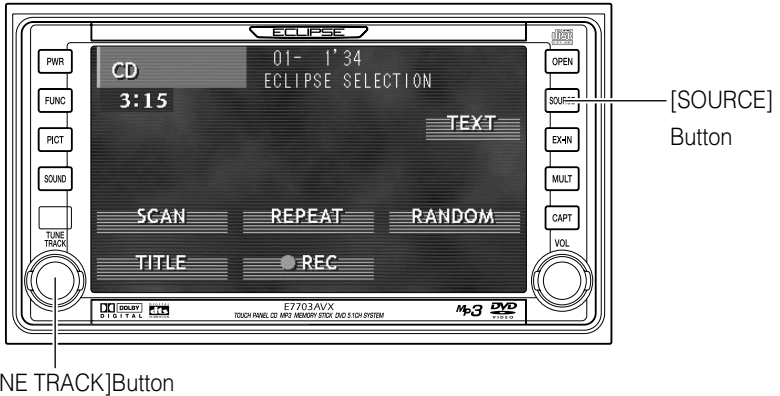

## Listening to CD

- 1 Press the [SOURCE] panel button.  
Switches to Audio Source Menu Screen.

- 2 Touch the **DVD/CD** touch switch.  
Switches to CD screen and starts playback.



Caution

Playback may be intermittent when there is a scratch on a CD or when the recorded side is dirty.

## Advancing to the next track or returning to the beginning of the track being played

- 1 Turn the [TUNE TRACK] panel button briefly (less than 1 second).  
Turn right: Advances to the next track.  
Turn left: Returns to the beginning of the track being played. (Repeat turning for previous track.)

## Fast Forward/Rewind

- 1 Turn the [TUNE TRACK] panel button until a beep is heard.

Turn right: Fast forward.

Turn left: Rewind.

The fast-forward/rewind will continue while [TUNE TRACK] button is held. The fast-forward/rewind action will stop when button is released.

## Playing the beginning of tracks (SCAN)

- 1 Touch the **SCAN** touch switch.

Play the first 10 seconds of each track within a CD.

Touching the **SCAN** touch switch again will cancel the operation.

## Repeating the same track (REPEAT)

- 1 Touch the **REPEAT** touch switch.

Repeats the currently playing track.

Touching the **REPEAT** touch switch again will cancel the operation.

## Playing tracks in random order (RANDOM)

- 1 Touch the **RANDOM** touch switch.

Plays the tracks random order.

Touching the **RANDOM** touch switch again will cancel the operation.



- Occasionally the same track happens to be played (selected) two or more times in a row; this is normal operation and is no sign of a problem.

- Doing random playback, touch the **REPEAT** touch switch to repeat the track being played. To cancel repeat play (go back to random play), touch the **REPEAT** touch switch again.

During playback a particular track: The track being played is played repeatedly.

During searching: The following track is played repeatedly.

## Creating a title for a CD

A CD title can be created and displayed.



- 30 titles can be stored.
- A maximum of 18 characters may be entered per title.

### 1 Touch the **TITLE** touch switch briefly (less than 1 second).

The screen will switch to the disc title setting mode. Default character type is upper-case alphabet.



### 2 Touch one of the switch **ABC** , **abc** , **123/!"#** touch switch.

**ABC** : Default character type is upper-case alphabet.

**abc** : Default character type is lower-case alphabet.

**123/!"#** : Default character type is numerical, symbol.

### 3 Touch the character touch switch.



- To enter symbols, touch the **!"#** touch switch when the numerical character input is selected.
- Touch the **RETURN** touch switch to delete the character that was just entered.
- To change the type of character to be entered, repeat step **2** and **3**.
- A maximum of 18 characters may be entered per title.

Upper case characters,  
alphabet characters

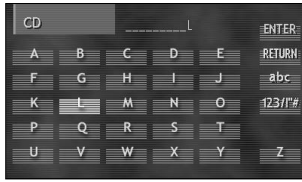

Lower case characters,  
alphabet characters

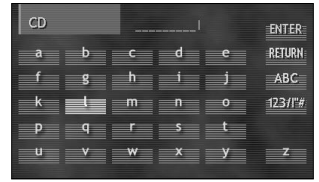

Numerical character

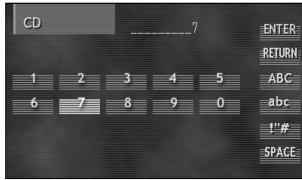

Symbol

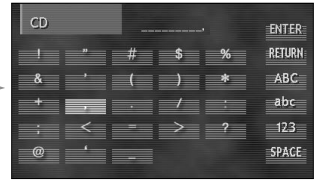

- 4 Touch the **ENTER** touch switch to exist disc title setting mode.

The disc title is now memorized.

## Deleting a previously created title

- 1 Touch (2 seconds or more) the **TITLE** touch switch.

The title has now been deleted.



## Displaying CD TEXT by scrolling

CD TEXT (such as disc titles and track titles) stored in the memory can be displayed. A maximum of 18 characters are displayed on the display area at one time. When the CD TEXT exceeds 18 characters, it is displayed by scrolling.

After the disc title is displayed by scrolling, track titles are displayed by scrolling.

The title display will be fixed after track titles are scrolled.



- This function cannot be used when no CD titles or track titles are displayed on the display screen of this unit.
- Depending on the equipment used for entering titles, the titles may not be displayed properly.
- Some title characters may not be displayed for some discs.

- 1 Touch the **TEXT** touch switch briefly (less than 1 second).



# How to operate the MP3 player

It is assumed here that a CD has already been loaded into the unit.

## About MP3



The making of MP3 files by recording from sources such as broadcasts, records, recordings, videos and live performances without permission from the copyright holder for uses other than personal enjoyment is prohibited.

### What is MP3?

MP3 (MPEG Audio Layer III) is a standard format for audio compression technology. By using MP3, a file can be compressed to one-tenth the size of the original.

This unit has limitations on MP3 file standards and recorded media and formats that can be used.

### Playable MP3 file standards

- Supported standards: MPEG-1 Audio Layer III  
MPEG-2 Audio Layer III
- Supported sampling frequencies: 32, 44.1, 48 (kHz)
- Supported bit rate: 8, 16, 24, 32, 40, 48, 56, 64, 80, 96, 112, 128, 144, 160, 192, 224, 256, 320 (kbps)
  - \* Supports VBR.
  - \* Does not support free format.
  - \* Bit rates vary for MPEG-1 and MPEG-2.
- Supported channel modes: stereo, joint stereo, dual channel, monaural

### ID3 tags

MP3 files have an "ID3 Tag" that allows input of information so that data such as song title and artist can be saved.

This unit supports ID3v.1.0 and ID3v.1.1 tags.

## Media

Media capable of playing MP3 includes CD-ROM, CD-R and CD-RW discs. Compared to CD-ROM media commonly used for music discs, CD-R discs are fragile in high temperature/high humidity environments and one section of the CD-R may become incapable of playback. Fingerprints or scratches on the disc may prevent playback or cause skipping during playback. Sections of a CD-R may deteriorate if left inside a vehicle for long periods of time. It is also recommended that CD-R discs be kept in a light-blocking case because the discs are vulnerable to ultra-violet light.

## Format of discs

The format of discs to be used must be ISO9660 Level 1 or Level 2. Control items for this standard are as follows:

- Maximum directory layers: 8 layers
- Maximum characters for folder names/file names: 31 (including ". " and 3 letter file extension)
- Allowable characters for folder names/file names: A~Z, 0~9, \_ (underscore)
- Number of files/folders possible on a single disc: 250

[Configuration example for CD supporting MP3]

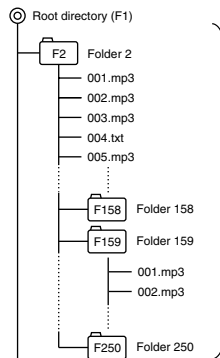

Number of files/folders possible on a single disc is 250. Files aside from MP3 files (Example: 004.txt) also count as single files.

- Total number of folders possible on a single disc: 250
- Maximum folders this unit can recognize: 250\*

\*: A root directory is counted as one folder.

## File names

Only files with the MP3 file extension ".mp3" can be recognized as MP3 and played. Be sure to save MP3 files with the ".mp3" file extension. The "MP" letters of the file extension will be recognized whether entered as uppercase letters or lowercase letters.



If the ".mp3" file extension is attached to a file other than an MP3 file, that file will be mistakenly recognized by the unit as an MP3 file and played, resulting in loud noise output that can damage the speakers. Be sure to avoid attaching the ".mp3" file extension to files that are not MP3 files.

## Multi-sessions

Multi-sessions are supported, and playing of CD-R and CD-RW discs with annotated MP3 files is possible. However, when "Track at once" has been written, close the session or process the warning message. Standardize the format of each session without changing the format.

## Playing MP3

When a disc with recorded MP3 files is inserted, the unit first checks all the files on the disc. No sound is output while the unit is checking the files on the disc. It is recommended that the disc be recorded without files other than MP3 files and without unnecessary folders in order to speed up the checking of disc files by the unit.

## MP3 playing time display

It is possible that playing time will not be correct, depending on the writing condition of the MP3 file.

\* It is possible that playing time will not be correct when VBR Fast Up/Down is operated.

## Display order of MP3 file/folder names

Names of MP3 folders and files within the same level are displayed in the following order.

1. MP3 folders displayed first, by ascending order of numbers, letters.
2. Files displayed next, by ascending order of numbers, letters.





### Example of MP3 file structure

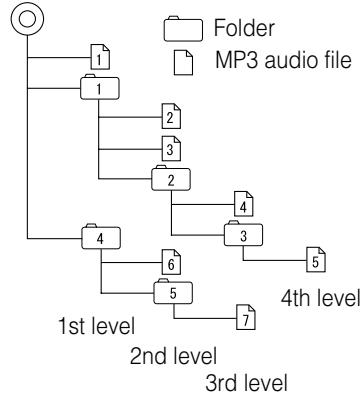

The following operations are based on the example MP3 file structure given above.

## Listening to MP3 files

- 1 Press the [SOURCE] button in the panel switches.  
The display will change to the audio source menu screen.
- 2 Touch the **DVD/CD** touch switch.  
Playback will then start.



- Normally, tracks are played back in the order 1 → 2 → 3 → 4 → 5 → 6 → 7.
- If there is more than one MP3 file or folder at a particular level, the files will be played back in alphanumeric character order.
- If Audio CD tracks (CD-DA) and MP3 data are mixed together on the same disc, touch the **DVD/CD** touch switch to change to MP3 playback.



## Selecting a folder to listen to

You can select a particular folder on the disc to listen to.

- 1 Touch the  touch switch.

The audio files contained in the selected folder will be displayed.



If there are 3 or more folders within the same level, touch the  or  touch switch to change the display and then select the folder that you would like to listen to.

## Selecting a file to listen to



You can select a particular file in a folder to listen to.

### Selecting using the touch switches

- 1 Touch the  touch switch.

The selected file will then be played back. In addition, the file name and folder name for the selected file will be displayed on the screen.



If there are 3 or more files within the same folder, touch the  or  touch switch to change the display and then select the file that you would like to listen to.

### Selecting using the panel switches

- 1 Turn the [TUNE TRACK] panel button briefly (less than 1 second).

When turned clockwise: The next audio file is selected  
 When turned counterclockwise: Playback returns to the start of the file currently being played (or to the previous file if turned again)

The selected file will then be played back. In addition, the file name and folder name for the selected file will be displayed on the screen.

## Displaying the next higher-up level

This displays the folders and files in the next higher-up level from the level that is being played back.

### 1 Touch the **RTN** touch switch.

The next higher-up level of folders and files from the currently-displayed level will be displayed on the screen.



Refer to page 81 for an example of the folder and file hierarchy for MP3 files.

If you touch **RTN** while the 2nd level files and folders shown on the screen as "2", "3" and "2" are being displayed, the 1st level files and folders shown as "1", "1" and "4" will be displayed.

## Playing the beginnings of tracks (SCAN)

### 1 Touch the **SCAN** touch switch.

If you touch the switch briefly (for less than 1 second), the first 10 seconds will be played back of all the files at the same level as the file currently being played back.

If you touch the switch for longer (more than 1 second), the first 1 seconds of the 1st tracks in all folders will be played back.

Touch the **SCAN** touch switch once more to cancel this operation.



## Playing the same files repeatedly (REPEAT)

### 1 Touch the **REPEAT** touch switch.

If you touch the switch briefly (for less than 1 second), the file that is currently being played back will be played back again.

If you touch the switch for longer (more than 1 second), all files contained in folders at the same level as the current folder will be played back again.

Touch the **REPEAT** touch switch once more to cancel this operation.



## Playing files in random order (RANDOM)

### 1 Touch the **RANDOM** touch switch.

If you touch the switch briefly (for less than 1 second), all files contained in folders at the same level as the current folder will be played in random order.

If you touch the switch for longer (more than 1 second), all files in all folders will be played back in random order.

Touch the **RANDOM** touch switch once more to cancel this operation.



ATTENTION

- If you touch **REPEAT** while "RANDOM" is selected, the file currently being played back will be repeated. In addition, if you press **REPEAT** once more during playback, then playback will return to "RANDOM". Files will be repeated as follows.
  - While a file is being played back: The file currently being played back will be repeated.
  - When you change to the next file: The next file selected will be played back.
- This may result in the same file being played back continuously, but this is not a malfunction.

# How to operate the Memory Stick player

Music data recorded on "MG Memory Stick" with ATRAC 3 (an audio compression technology) can be played on this unit. Recording from music CD to the MG Memory Stick is also possible. The following explanation for the operation is made assuming that the MG Memory Stick has already been inserted.



- Artist names and music titles (track titles) can be displayed when they are recorded on the MG Memory Stick. A maximum of 18 characters (1 byte alphabets or symbols) can be displayed.
- Music data recorded with ATRAC3 Plus cannot be played.
- Music data recorded with MP3 cannot be played.

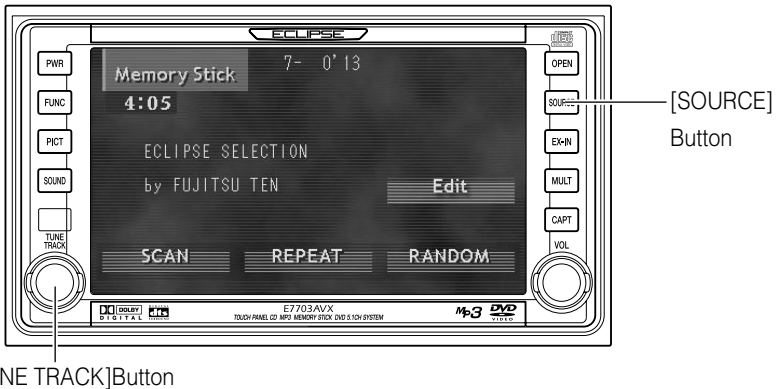

## Listening to Memory Stick

- 1 Press the [SOURCE] panel button.  
Switches to Audio Source Menu Screen.
- 2 Touch the **Memory Stick** touch switch.  
Switches to Memory Stick screen and starts playback.

## Advancing to the next track or returning to the beginning of the track being played

- 1 Turn the [TUNE TRACK] panel button briefly (less than 1 second).  
Turn right: Advances to the next track.  
Turn left: Returns to the beginning of the track being played. (Repeat turning for previous track.)

## Playing the beginning of tracks (SCAN)

- 1 Touch the **SCAN** touch switch.

Play the first 10 seconds of each track within a Memory Stick.

Touching the **SCAN** touch switch again will cancel the operation.

## Repeating the same track (REPEAT)

- 1 Touch the **REPEAT** touch switch.

Repeats the currently playing track.

Touching the **REPEAT** touch switch again will cancel the operation.

## Playing tracks in random order (RANDOM)

- 1 Touch the **RANDOM** touch switch.

Plays the tracks random order.

Touching the **RANDOM** touch switch again will cancel the operation.



ATTENTION

- Occasionally the same track happens to be played (selected) two or more times in a row; this is normal operation and is no sign of a problem.
- Doing random playback, touch the **REPEAT** touch switch to repeat the track being played. To cancel repeat play (go back to random play), touch the **REPEAT** touch switch again.

During playback a particular track: The track being played is played repeatedly.

During searching: The following track is played repeatedly.

## Recording on Memory Stick

Using ATRAC3 audio compression technology, this unit compresses the music data played on the built-in CD player and records the data on the MG Memory Stick. Only recording from music CDs is possible.

If the recorded CD data has no interval, tracks may not be split properly.

As this unit supports SCMS (Serial Copy Management System), MG Memory Stick recording from media (such as CD-R and CD-RW) digitally recorded from music CDs is not possible. Recording data of copy-proof music CDs is not possible either.

Music CDs recorded with DTS cannot be recorded.

Emphasis-recording in music CDs will be recorded with emphasis.



- Unrecorded contents, deleted music and vocal data caused by problems, malfunctions and defects of this unit will not be warranted.
- Use of your recordings other than for the personal entertainment is strictly prohibited by the copyright law without permission from the copyright holder.
- Unreproducible recordings should be test recorded first in order to ensure all music and vocal data are recorded properly.

**1** Insert the MG Memory stick to be recording the track and music CD.

**2** Touch the **REC** touch switch on the CD operation screen.

Switches to the ATRAC3 recording mode.

### Setting recording method

A MG Memory Stick recording method can be selected.

The following settings can be selected in the ATRAC3 recording mode.

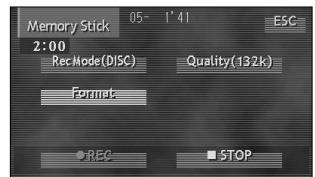

Item	Function
Rec Mode	Selects the tracks to be recorded.
Quality	Selects the recording sound quality.

### Selecting tracks to be recorded

The tracks to be recorded can be selected.

**1 Touch the **Rec Mode** touch switch.**

The selecting track mode will change as follows each time you touch the **Rec Mode** touch switch.

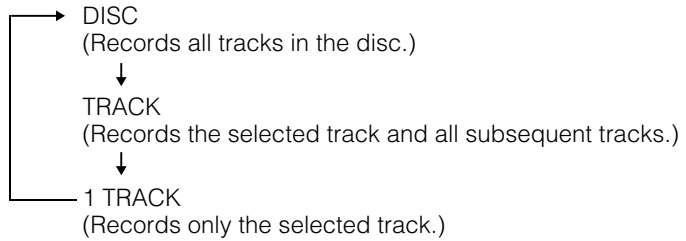
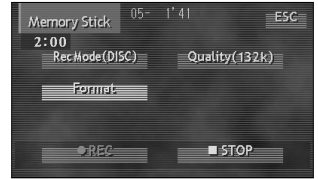

### Setting sound quality

The recording sound quality (the recording bit rate) can be set. The recording bit rate may be selected from 66k, 105k, and 132k. Sound quality and data size increases as the bit rate increases.

**1 Touch the **Quality** touch switch.**

The recording bit rate will change as follows each time you touch the **Quality** touch switch.

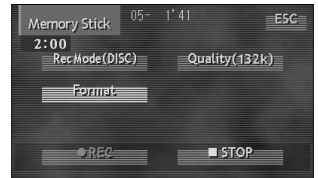
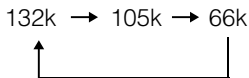



## Formatting Memory Stick (quick format)

Memory Stick can be formatted.

- 1 Touch (2 seconds or more) the **Format** touch switch.

MG Memory stick will be formatted.  
touch switch.

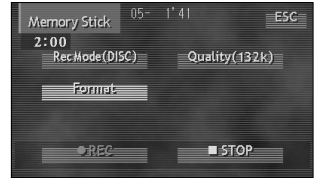

ATTENTION

- Do not turn OFF the power or the engine switch while formatting. The recording will be interrupted and the data may be damaged.
- New MG Memory Stick may not be used without formatting. In that case, format (quick format) the stick on this unit so music can be recorded (Hi-Fi directory format). The stick formatted on a unit other than exclusive MG Memory Stick unit may not be usable on this unit.

## Recording on MG Memory Stick

- 1 Touch the **REC** touch switch.

A CD is played and recording starts. In case TRACK or 1 TRACK was selected at the “Selecting tracks to be recorded” step, select tracks using the [TUNE TRACK] button of the panel switch and start recording.

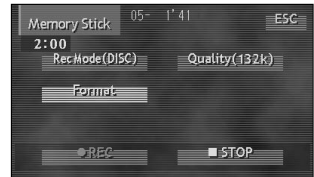

ATTENTION

- Do not turn OFF the power or the engine switch while recording. Doing so may damage the data.
- Touch **STOP** touch switch to stop the recording.

## Editing recorded Memory Stick

Track titles and artist names can be entered to the recorded Memory Stick. The file list may also be edited.

The track titles and artist names entered or edited by a personal computer cannot be edited on this unit.

- 1 Touch the **Edit** touch switch on the Memory Stick operation screen.

Switches to ATRAC 3 edit mode.



### Creating title name

- 1 Touch the file to be creating the title name.

When the touch switch is pressed, touch switch display color changes to the selected color.



In case there are more than 6 files, touch **▲** or **▼** touch switch to change the display, and select files for entering title names.

- 2 Touch the **TITLE** touch switch briefly (less than 1 second). The screen will switch to the disc title setting mode. Default character type is upper-case alphabet.
- 3 Touch one of the switch **ABC**, **abc**, **123/!"#** touch switch
  - ABC** : Default character type is upper-case alphabet.
  - abc** : Default character type is lower-case alphabet.
  - 123/!"#** : Default character type is numerical, symbol.

#### 4 Touch the character touch switch.



- To enter symbols, touch the **!"#** touch switch when the numerical character input is selected.
- Touch the **RETURN** touch switch to delete the character that was just entered.
- To change the type of character to be entered, repeat step **3** and **4**.
- A maximum of 256 characters may be entered per title.

Upper case characters,  
alphabet characters

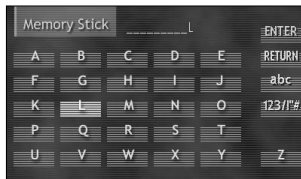

Lower case characters,  
alphabet characters



Numerical character



Symbol



#### 5 Touch the **ENTER** touch switch to exist disc title setting mode.

The title name is now memorized.

#### 6 Touch the **ESC** touch switch to exist ATRAC3 edit mode.

## Creating artist name

### 1 Touch the file to be creating the artist name.

When the touch switch is pressed, touch switch display color changes to the selected color.



In case there are more than 6 files, touch **▲** or **▼** touch switch to change the display, and select files for entering artist names.

### 2 Touch the **ARTIST** touch switch briefly (less than 1 second).

The screen will switch to the disc title setting mode. Default character type is upper-case alphabet.

### 3 Touch one of the switch **ABC**, **abc**, **123/!"#** touch switch.

**ABC** : Default character type is upper-case alphabet.

**abc** : Default character type is lower-case alphabet.

**123/!"#** : Default character type is numerical, symbol.

#### 4 Touch the character touch switch.



- To enter symbols, touch the **!"#** touch switch when the numerical character input is selected.
- Touch the **RETURN** touch switch to delete the character that was just entered.
- To change the type of character to be entered, repeat step **3** and **4**.
- A maximum of 256 characters may be entered per title.

Upper case characters,  
alphabet characters

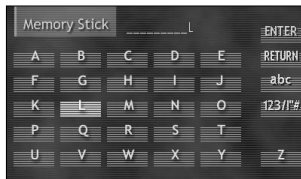

Lower case characters,  
alphabet characters



Numerical character



Symbol



#### 5 Touch the **ENTER** touch switch to exist disc title setting mode.

The artist name is now memorized.

#### 6 Touch the **ESC** touch switch to exist ATRAC3 edit mode.

## Deleting recorded file

The recorded files can be deleted. There are two deleting methods: deleting selected files or all files.

### Deleting selected files

#### 1 Touch the file to be deleted.

When touch switches touched, the touch switch display color changes to the selected color.



- Do not turn OFF the power or engine switch while deleting the file(s). Doing so may damage the data.
- In case there are more than 6 files, touch **▲** or **▼** touch switch to change the display, and select the file to be deleted.

#### 2 Touch (2 seconds or more) the **Del** touch switch.

The selected file is deleted.

#### 3 Touch the **ESC** touch switch to exist ATRAC3 edit mode.

### Deleting all files

#### 1 Touch (2 seconds or more) the **All Del** touch switch.

The all files are deleted.



- Do not turn OFF the power or engine switch while deleting the file(s). Doing so may damage the data.

#### 2 Touch the **ESC** touch switch to exist ATRAC3 edit mode.

# How to operate the DVD player

## Before using the DVD player

This unit can play high quality images and high quality digital sound of DVD videos. It is also possible to switch between different languages recorded on the DVD video (dubbing, subtitles, etc.), and with videos having several angles of the same scene recorded, the preferred angle can be selected and played.



Caution

This unit includes copyright protection technology used in accordance with US patents and other intellectual property rights owned by Macrovision Corporation and other entities. Use of this copyright protection technology requires approval from Macrovision Corporation and the technology must not be used for audiovisual purposes aside from general household use without special approval from Macrovision Corporation. Modification and disassembly of this technology is prohibited.

## DVD video characteristics

### **About Multiple Languages**

Some DVD discs have dialog recorded in several different languages, and the language can be switched during playback in the same way as multilingual TV broadcasts.

### **About Multiple Angles**

Some DVD discs have a single scene recorded from several different angles (multiple angle), and the preferred angle can be switched during playback.



### **About Subtitles**

Some DVD discs have subtitles recorded in several different languages, and the subtitles can be switched during playback. The video can also be played without any subtitles displayed.

## About discs

### About playable discs

Discs using color television methods, NTSC and PAL, are playable on this unit.

Playable Disc Types and Their Marks	Size/Playing Surface	Maximum Playing Time
 	12 cm/single-sided    1 layer 2 layer  12 cm/double-sided    1 layer 2 layer	<Using MPEG 2> 133 min. 242 min. 266 min. 484 min.

### About region codes of playable discs

Some DVD discs display a  ("Region Code"). The mark (a number) shows the geographical region where the disc can be played. This unit cannot play discs that do not show "4" or "ALL" on the mark. Attempting to play other discs will result in display of a message saying "Can not read disk. Please check disc." Even discs that do not display the region mark may in fact be controlled by region and may not be playable on this unit.



Caution

The playing condition is determined by the intention of the DVD/software creator. Some functions may not perform during operation because this unit is playing the disc according to content specifications intended by the software creator. Be sure to consult the explanatory material provided with the disc to be played.



### **About sound system capability**

This unit supports Dolby Digital (5.1 ch), DTS (5.1 ch), LPCM, SDDS and Dolby Pro Logic, enabling the creation of richly vibrant acoustics such as found in a theater or concert hall. The unit can play discs bearing the "Dolby Digital (5.1 ch)" or "DTS (5.1 ch)" mark on the disc or package. For information on sound adjustment when playing DVD video, refer to "Adjusting the surround system" (page 44).



A DVD video bearing the "Dolby Digital (5.1 ch)" or "DTS (5.1 ch)" mark can still be played even if a center speaker with power amplifier and subwoofer with power amplifier are not connected, but it will not be played with the 5.1 channel method.

### **About marks displayed on discs**

The following marks may be displayed on a DVD disc or its package.

Mark	Meaning
	Shows number of voice tracks.
	Shows number of subtitle languages.
	Shows number of filmed angles.
	Shows available aspect ratio (television screen horizontal to vertical ratio). • "16:9" is wide screen, "4:3" is standard screen.
	Shows playable region code. • ALL indicates worldwide. A number indicates a specific region code. "4" is the region for the Australia.

### **About DVD disc structure**

Videos and songs recorded on a DVD are divided into many segments. Large segments are called "titles", and each title has a number ("title number").

Title segments are further divided into smaller segments called "chapters", and each chapter has a number ("chapter number").

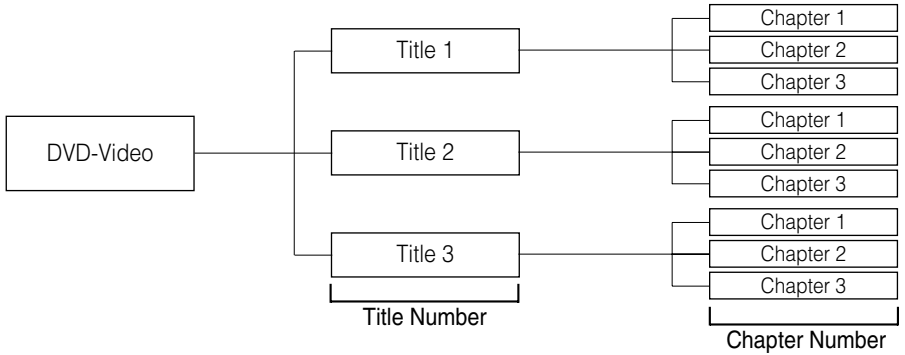

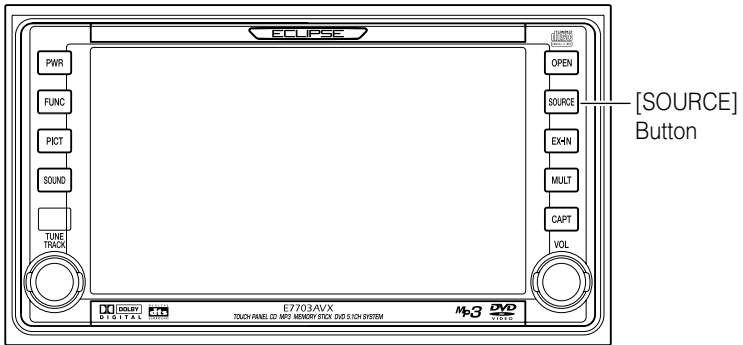

## Watching a DVD

The following explanation assumes that a DVD has already been inserted into the unit.

A DVD can be watched only if the vehicle is completely stopped in a safe location with the parking brake set and the ignition switch turned to ON or ACC. (Only sound can be heard if a DVD is played while the car is in motion.)

- 1 Press the [SOURCE] panel button.

Switches to Audio Source Menu Screen.

- 2 Touch the **DVD/CD** touch switch.

Switches to DVD screen and starts playback.



Some discs may not automatically start playing, depending on the disc. Use the menu screen recorded on the disc to start playback.

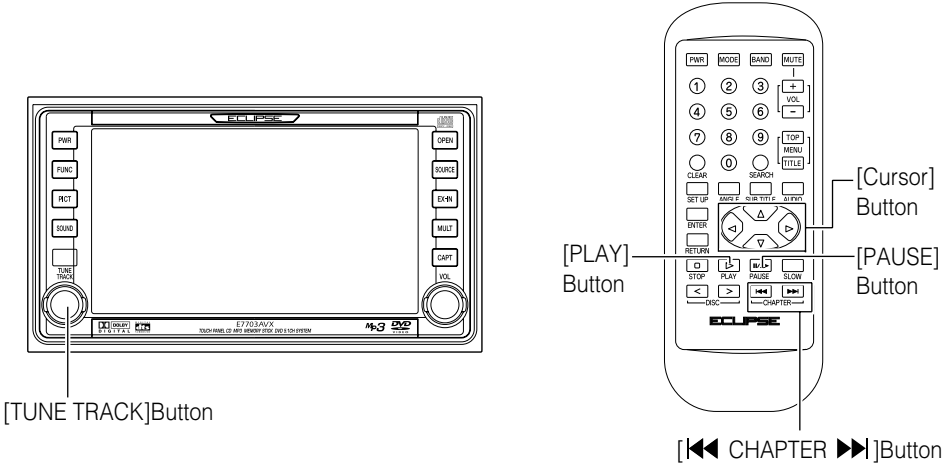

## Using the menu screen

It is possible to use the menu recorded on the disc. This function can only be operated with the remote control.



Recorded menu items will differ by disc. Some functions may not perform during operation because playback is following disc content specifications.

- 1** Press the [TOP] or [TITLE] button.

Switches to Menu Screen recorded on the disc.
- 2** Press the [Δ], [∇], [◀] or [▶] cursor button and select the Play Menu.
- 3** Press [ENTER] button.

The selected item will be played.

## Fast-Forward/Rewind

The image can be controlled during playback. This function can be operated by using either the panel buttons or the remote control.

### Using panel button

- 1 Turn the [TUNE TRACK] panel button until a beep is heard.**

Turn right: Fast-forwards.

Turn left: Rewinds.

The fast-forward/rewind will continue while the [TUNE TRACK] button is held. The fast-forward/rewind action will stop when the button is released.

### Using remote control

- 1 Press the [◀◀CHAPTER▶▶] button until a beep is heard.**

[▶▶] button: Fast-forwards.

[◀◀] button: Rewinds.

The fast-forward/rewind will continue while the [◀◀ CHAPTER ▶▶] button is held. The fast-forward/rewind action will stop when the button is released.

## Pausing/Advancing the video

This function can only be performed with the remote control.

- 1 Press the [PAUSE] button during DVD playback.**

The video will pause.

The video will advance each time the [PAUSE] button is pressed again while paused.

- 2 Press the [PLAY] button.**

Restarts playback.

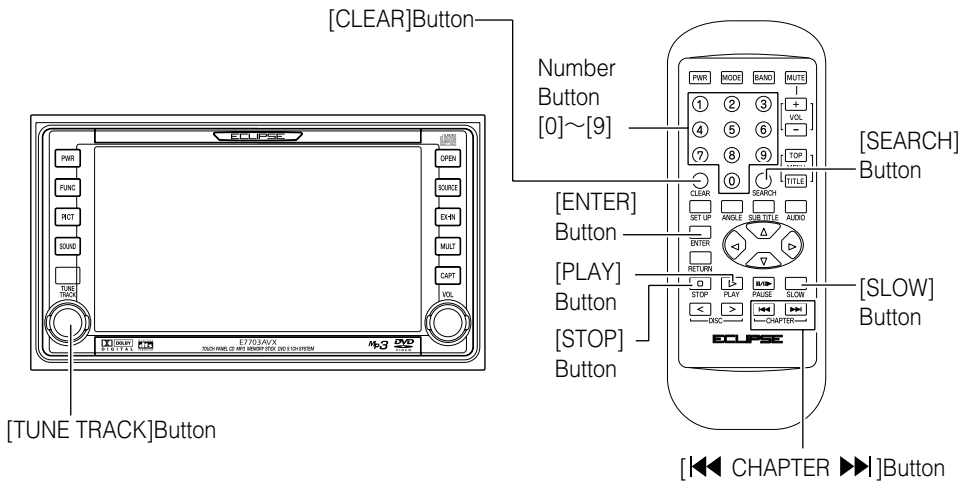

## Stopping playback

This function can only be performed with the remote control.

- 1** Press the [STOP] button during DVD playback.
- 2** Press the [PLAY] button.  
Restarts playback.

## Using slow motion

This function can only be performed with the remote control.

- 1** Press the [SLOW] button during DVD playback.  
Video will play in slow motion.
- 2** Press the [PLAY] button.  
Restarts playback.

## Searching for a desired chapter

It is possible to search for a particular video segment by title and chapter or by menu number (number for divided segments).

### Searching by chapter

This function can be performed with either the panel buttons or the remote control.

#### Using the panel buttons

**1 Turn the [TUNE TRACK] panel button briefly (less than 1 second).**

Turn right: Advances to next chapter.

Turn left: Returns to previous chapter.

The currently selected chapter number will be shown on the display.

#### Using the remote control

**1 Press the [◀◀CHAPTER▶▶] button briefly (less than 1 second).**

[▶▶]: Advances to next chapter.

[◀◀]: Returns to previous chapter.

The currently selected chapter number will be shown on the display.

### Searching by chapter/title number

This function can only be performed with the remote control.

**1 Press the [SEARCH] button.**

Switches to next chapter and then title each time the [SEARCH] button is pressed.

**2 Enter a menu number with the [0]~[9] number buttons.**

Entered numbers can be deleted with each pressing of the [CLEAR] button.

**3 Press the [ENTER] button.**

Begins playing the selected chapter.

## Playing the beginnings of chapters (SCAN)

- 1 Touch the DVD Playback Screen.

Switches to DVD Operation Screen.



The system returns to the DVD video playback screen if the DVD Operation Screen is not used within 6 seconds.

- 2 Touch the **SCAN** touch switch.

Plays the first 10 seconds of each chapter within a title.

Pressing **SCAN** touch switch again will cancel the operation.



## Repeating titles (REPEAT)

- 1 Touch the DVD Playback Screen.

Switches to DVD Operation Screen.



The system returns to the DVD video playback screen if the DVD Operation Screen is not used within 6 seconds.

- 2 Touch the **REPEAT** touch switch.

Repeats the currently playing chapter.

Touching the **REPEAT** touch switch until "REPEAT TITLE" is displayed will repeat all the chapters within a title.

Pressing **REPEAT** touch switch again will cancel the operation.





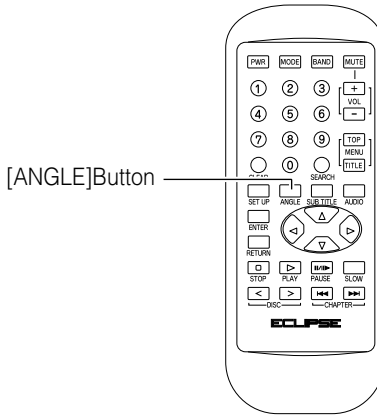

## Switching the video angle

When several angles of a scene are recorded on a disc, the angle can be switched.

This function can only be used when the DVD player angle display setting is set to ON. (For operation details, refer to "Angle display setting," page 115.)

This function can only be performed with the remote control.

- 1 Press the [ANGLE] button when the multiple angle mark is displayed.

Switches the angle number each time the button is pressed and switches the video angle.

Multiple Angle Mark



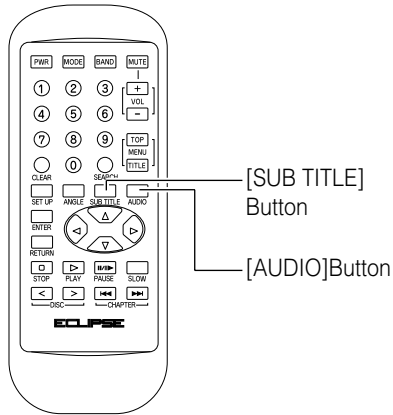

## Switching subtitle languages

When subtitles in several languages are recorded on a disc, the subtitles can be switched.

This function can only be performed with the remote control.

- 1 Press the [SUB TITLE] button.

Switches the subtitle number each time the button is pressed and switches the displayed subtitle language.

## Switching dubbed voice languages

When dubbed voices in several languages are recorded on a disc, the voices can be switched.

This function can only be performed with the remote control.

- 1 Press the [AUDIO] button.

Switches the voice number each time the button is pressed and switches the language of played voices.

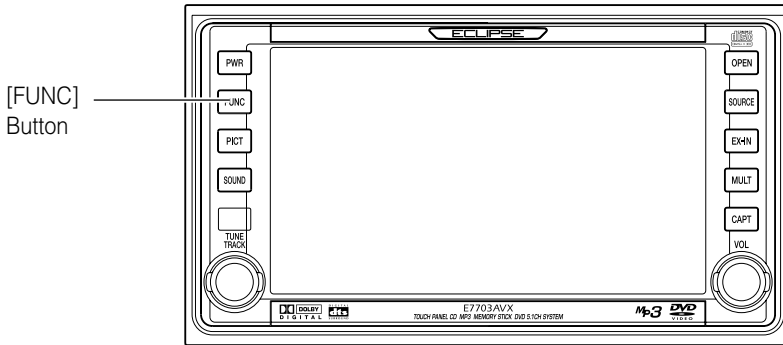

## Setting the DVD player

The language preference for voices, subtitles and menu display used during DVD playback can be set in advance. Optional display of the multiple angle mark, viewer restriction and other functions can also be set.

- 1 Press the [FUNC] panel button.

Switches to Function Mode.

Pressing the [FUNC] button again will cancel Function Mode.

- 2 Touch the **DVD** touch switch.

Switches to DVD Setting Screen.



**3** Touch any of the touch switches.

Settings can be made for the following items.

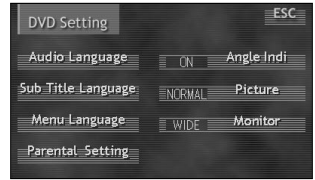

Touch Switch	Function	Refer to Page
<b>Audio Language</b>	Sets the language of voices for video playback.	108
<b>Sub Title Language</b>	Sets the language of subtitles for video playback.	110
<b>Menu Language</b>	Sets the language of displayed menus.	112
<b>Parental Setting</b>	Restricts DVD videos that can be played.	114
<b>Angle Indi</b>	Sets display/non-display of multiple angle mark.	115
<b>Picture</b>	Reduces noise from video.	115
<b>Monitor</b>	Sets screen size.	116

**Voice language setting**

Allows selection of a preferred language for playback. The setting can be made by either selecting the language from a list or by entering a language code.



Language switching cannot be performed if the selected language is not recorded on the disc.

**1** Touch the **Audio Language** touch switch.

Switches to Voice Language Setting Screen.

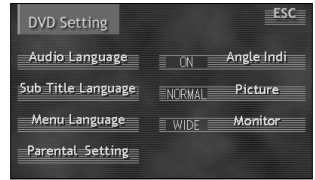

### Selecting language from list

English, Japanese, Italian or French can be selected from the list.

Enter a language code to select a language other than one of these.

- 1 Touch the language to play.**
- 2 Touch the **ESC** touch switch.**  
Returns to DVD Setting Screen.
- 3 Touch the **ESC** touch switch.**  
Returns to first screen of Function Mode.



### Setting language by code entry

Set a language not on the list by entering its language code.

- 1 Touch the **OTHER** touch switch.**
- 2 Touch the number buttons to enter a language code.**  
The code will be entered. (For language codes, refer to "Table of language codes," page 117).  
Entered numbers can be deleted with each touching of the **RETURN** touch switch.
- 3 Touch the **ENTER** touch switch.**  
Sets the language.
- 4 Touch the **ESC** touch switch.**  
Returns to DVD Setting Screen.
- 5 Touch the **ESC** touch switch.**  
Returns to first screen of Function Mode.



## Subtitle language setting

Allows selection of a preferred subtitle language for display during playback. The setting can be made by either selecting the language from a list or by entering a language code.



Language switching cannot be performed if the selected language is not recorded on the disc.

- 1 **Touch the **Sub Title Language** touch switch.**

Switches to Subtitle Language Setting Screen.

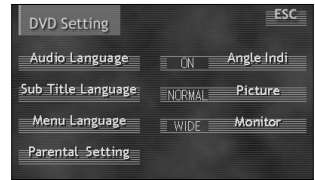

### **Selecting language from list**

English, Japanese, Italian or French can be selected from the list. Enter a language code to select a language other than one of these.

- 1 **Touch the language to play.**
- 2 **Touch the **ESC** touch switch.**

Returns to DVD Setting Screen.

- 3 **Touch the **ESC** touch switch.**

Returns to first screen of Function Mode.

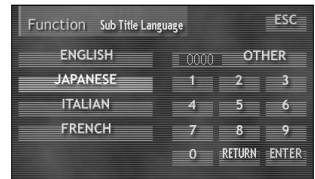

### Setting language by code entry

Set a language not on the list by entering its language code.

**1 Touch the **OTHER** touch switch.**

**2 Touch the number buttons to enter a language code.**

The code will be entered. (For language codes, refer to "Table of language codes," page 117).

Entered numbers can be deleted with each touching of the **RETURN** touch switch.

**3 Touch the **ENTER** touch switch.**

Sets the language.

**4 Touch the **ESC** touch switch.**

Returns to DVD Setting Screen.

**5 Touch the **ESC** touch switch.**

Returns to first screen of Function Mode.



## Menu language setting

Allows selection of a preferred menu language from those recorded on the disc. The setting can be made by either selecting the language from a list or by entering a language code.



Language switching cannot be performed if the selected language is not recorded on the disc.

- 1 **Touch the **Menu Language** touch switch.**  
Switches to Menu Language Setting Screen.

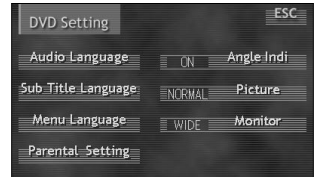

### Selecting language from list

English, Japanese, Italian or French can be selected from the list. Enter a language code to select a language other than one of these.

- 1 **Touch the language to display.**
- 2 **Touch the **ESC** touch switch.**  
Returns to DVD Setting Screen.
- 3 **Touch the **ESC** touch switch.**  
Returns to first screen of Function Mode.





### **Setting language by code entry**

Set a language not on the list by entering its language code.

**1 Touch the **OTHER** touch switch.**

**2 Touch the number buttons to enter a language code.**

The code will be entered. (For language codes, refer to "Table of language codes," page 117).

Entered numbers can be deleted with each touching of the **RETURN** touch switch.

**3 Touch the **ENTER** touch switch.**

Sets the language.

**4 Touch the **ESC** touch switch.**

Returns to DVD Setting Screen.

**5 Touch the **ESC** touch switch.**

Returns to first screen of Function Mode.



## Viewer restriction setting

This function allows restriction of viewing so that discs with adult themes or violent scenes will not be available to children. Viewer restriction can be set at different levels to match restriction ratings.



Restriction cannot be set for discs not having a viewer restriction level recorded.

**1 Touch the **Parental Setting** touch switch.**

Switches to Viewer Parental Setting Screen.

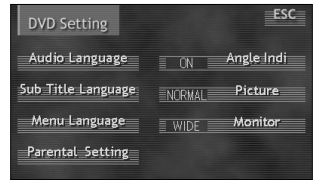

**2 Touch the number buttons to enter a password number (4 digits).**

Entered numbers can be deleted with each touching of the **RETURN** touch switch.

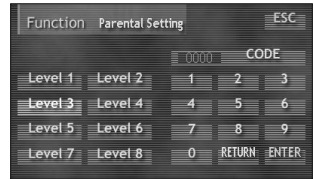

- Password condition at time of product purchase is "0000".
- Be sure to enter a password number. If a number is not entered, setting of viewer restriction will not be possible.

**3 Touch the **ENTER** touch switch.**

Registers the password number.

**4 Touch the viewer restriction level to be set.**

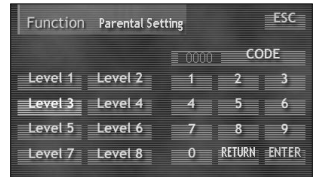

Viewer restriction levels are classified in 3 types.

Level 1 ...Plays only DVD software intended for children. (Playing of DVD software intended for general audiences or adult audiences is prohibited.)

Level 2~7...Plays only DVD software intended for children or general audiences. (Playing of DVD software intended for adult audiences is prohibited.)

Level 8 ...Plays all DVD software. (Factory setting)

- 5 Touch the **ESC** touch switch.**  
Returns to DVD Setting Screen.
- 6 Touch the **ESC** touch switch.**  
Returns to first screen of Function Mode.

### Angle display setting

Sets display/non-display of multiple angle mark during playback.

- 1 Touch the **Angle Indi** touch switch.**  
Switches between ON/OFF each time the **Angle Indi** touch switch is touched.

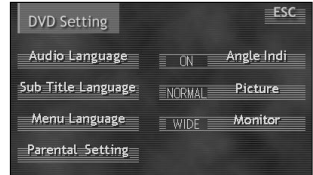

When the multiple angle mark display setting is set to "ON", the multiple angle mark will appear in the upper right corner of the screen when selection of multiple angles from a disc is possible.

- 2 Touch the **ESC** touch switch.**  
Returns to first screen of Function Mode.

### Video mode setting

Sets video mode for playback.

- 1 Touch the **Picture** touch switch.**  
Switches between modes in the following order each time the **Picture** is touched.

NORMAL → H-PRE → N-FLK

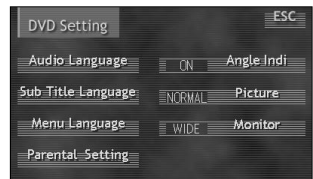

The video mode setting is a function that is enabled when image quality is extremely poor. DVDs that are purchased normally should be viewed with the setting at "NORMAL".

- 2 Touch the **ESC** touch switch.**  
Returns to first screen of Function Mode.

## Image size setting

### 1 Touch the **Monitor** touch switch.

Switches between modes in the following order each time the **Monitor** is touched.

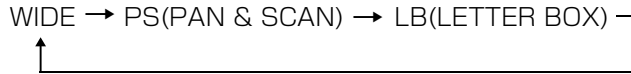
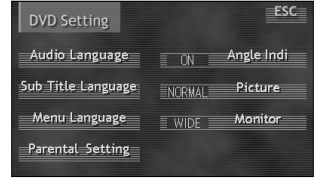

<WIDE>

Displays as wide screen image.

<PAN & SCAN>

Displays in wide screen size for wide screen television monitors and displays in letter box size for 4:3 regular television monitors.

<LETTER BOX>

Displays in wide screen size for wide screen television monitors and cuts off left and right edges to display in 4:3 size for 4:3 regular television monitors.

### 2 Touch the **ESC** touch switch.

Returns to first screen of Function Mode.



There are no problems with using this function as long as the customer views images privately in wide-screen format. However, if the images are compressed or enlarged for viewing for any commercial or public purpose, it may infringe the rights of the copyright holder under applicable copyright laws.

## Table of language codes

These codes are used to specify the language for audio tracks, subtitles and on-screen menu displays.

Language	Input code	Language	Input code
Japanese	1 0 0 1	Estonian	0 5 2 0
English	0 5 1 4	Basque	0 5 2 1
French	0 6 1 8	Persian	0 6 0 1
German	0 4 0 5	Finnish	0 6 0 9
Italian	0 9 2 0	Fiji	0 6 1 0
Spanish	0 5 1 9	Faroese	0 6 1 5
Dutch	1 4 1 2	Frisian	0 6 2 5
Russian	1 8 2 1	Irish	0 7 0 1
Chinese	2 6 0 8	Scots- Gaelic	0 7 0 4
Korean	1 1 1 5	Galician	0 7 1 2
Greek	0 5 1 2	Guarani	0 7 1 4
Afar	0 1 0 1	Gujarati	0 7 2 1
Abkhazian	0 1 0 2	Hausa	0 8 0 1
Afrikaans	0 1 0 6	Hindi	0 8 0 9
Amharic	0 1 1 3	Croatian	0 8 1 8
Arabic	0 1 1 8	Hungarian	0 8 2 1
Assamese	0 1 1 9	Armenian	0 8 2 5
Aymara	0 1 2 5	Interlingua	0 9 0 1
Azerbaijani	0 1 2 6	Interlingue	0 9 0 5
Bashkir	0 2 0 1	Inupiak	0 9 1 1
Byelorussian	0 2 0 5	Indonesian	0 9 1 4
Bulgarian	0 2 0 7	Icelandic	0 9 1 9
Bihari	0 2 0 8	Hebrew	0 9 2 3
Bislama	0 2 0 9	Yiddish	1 0 0 9
Bengali	0 2 1 4	Javanese	1 0 2 3
Tibetan	0 2 1 5	Georgian	1 1 0 1
Breton	0 2 1 8	Kazakh	1 1 1 1
Catalan	0 3 0 1	Greenlandic	1 1 1 2
Corsican	0 3 1 5	Cambodian	1 1 1 3
Czech	0 3 1 9	Kannada	1 1 1 4
Welsh	0 3 2 5	Kashmiri	1 1 1 9
Danish	0 4 0 1	Kurdish	1 1 2 1
Bhutani	0 4 2 6	Kirghiz	1 1 2 5
Esperanto	0 5 1 5	Latin	1 2 0 1

Language	Input code	Language	Input code
Lingala	1 2 1 4	Slovak	1 9 1 1
Laothian	1 2 1 5	Slovenian	1 9 1 2
Lithuanian	1 2 2 0	Samoan	1 9 1 3
Latvian	1 2 2 2	Shona	1 9 1 4
Malagasy	1 3 0 7	Somali	1 9 1 5
Maori	1 3 0 9	Albanian	1 9 1 7
Macedonian	1 3 1 1	Serbian	1 9 1 8
Malayalam	1 3 1 2	Siswati	1 9 1 9
Mongolian	1 3 1 4	Sesotho	1 9 2 0
Moldavian	1 3 1 5	Sundanese	1 9 2 1
Marathi	1 3 1 8	Swedish	1 9 2 2
Malay	1 3 1 9	Swahili	1 9 2 3
Maltese	1 3 2 0	Tamil	2 0 0 1
Burmese	1 3 2 5	Telugu	2 0 0 5
Nauru	1 4 0 1	Tajik	2 0 0 7
Nepali	1 4 0 5	Thai	2 0 0 8
Norwegian	1 4 1 5	Tigrinya	2 0 0 9
Occitan	1 5 0 3	Turkmen	2 0 1 1
Oromo	1 5 1 3	Tagalog	2 0 1 2
Oriya	1 5 1 8	Setswana	2 0 1 4
Panjabi	1 6 0 1	Tonga	2 0 1 5
Polish	1 6 1 2	Turkish	2 0 1 8
Pashto	1 6 1 9	Tsonga	2 0 1 9
Portuguese	1 6 2 0	Tatar	2 0 2 0
Quechua	1 7 2 1	Twi	2 0 2 3
Rhaeto-Romance	1 8 1 3	Ukrainian	2 1 1 1
Kirundi	1 8 1 4	Urdu	2 1 1 8
Romanian	1 8 1 5	Uzbek	2 1 2 6
Kinyarwanda	1 8 2 3	Vietnamese	2 2 0 9
Sanskrit	1 9 0 1	Volapuk	2 2 1 5
Sindhi	1 9 0 4	Wolof	2 3 1 5
Sangho	1 9 0 7	Xhosa	2 4 0 8
Serbo-Croatian	1 9 0 8	Yoruba	2 5 1 5
Sinhalese	1 9 0 9	Zulu	2 6 2 1

# How to operate the video CD player

A video CD recorded with Video-CD ver.2.0 can be played on this unit.



Video CD will be played as designed by producer, and may not be played as operated.

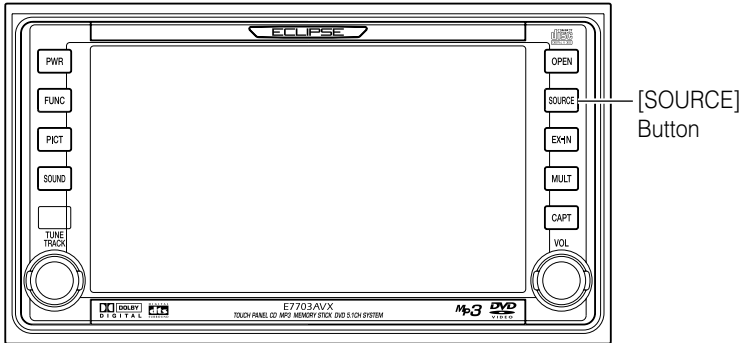

## Watching a video CD

The following explanation assumes that a video CD has already been inserted into the unit.

A video CD can be watched only if the vehicle is completely stopped in a safe location with the parking brake set and the ignition switch turned to ON or ACC. (Only sound can be heard if a video CD is played while the car is in motion.)

- 1 Press the [SOURCE] panel button.  
Switches to Audio Source Menu screen.
- 2 Touch the **DVD/CD** touch switch.  
Switches to video CD screen and starts playback.

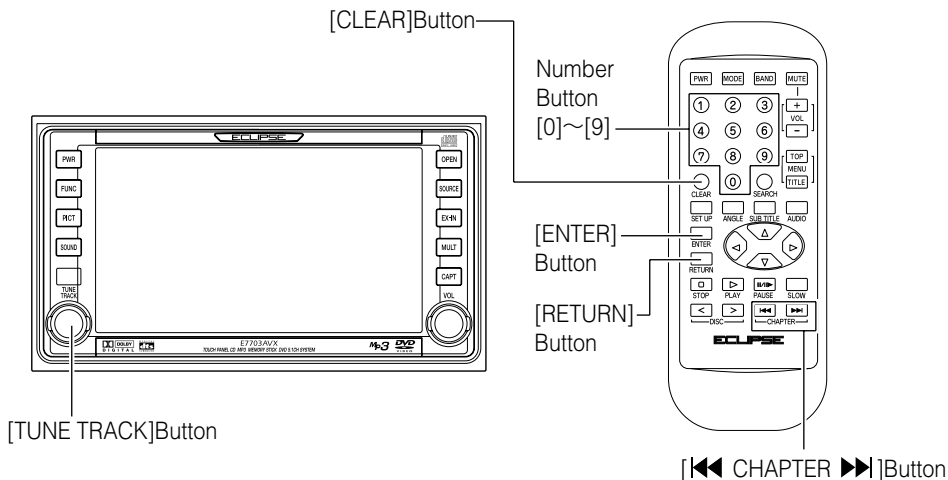

## Using the menu screen

When a video CD featuring PBC (Play Back Control) function is played, the menu screen will be displayed. With the PBC function, original menu items of a disc can be displayed and operated while PBC disc is played.

### Displaying menu screen

The menu screen can be displayed while a video CD featuring the PBC function is played.

**1 Press the [RETURN] remote control button.**

Switches display to the menu screen.



When a CD contains more than 1 page of the menu screen, the display can be switched by turning the [TUNE TRACK] button of the panel switch or by pressing the [CHAPTER] button of the remote control.

### Selecting menu list

**1 Enter a menu number with the [0] to [9] number button.**

Entered numbers can be deleted with each pressing of the [CLEAR] button.

**2 Press the [ENTER] button.**

Begins playing the selected menu.



## Advancing to the next scene or returning to the beginning of the scene being played

The image can be controlled during playback.

This function can be operated by using either the panel buttons or the remote control.

### Using panel button

- 1 Turn the [TUNE TRACK] panel button briefly (less than 1 second).**

Turn right: Advances to next track.

Turn left: Return to previous track.

The currently selected track number will be shown on the display.

### Using remote control

- 1 Press the [⏮ CHAPTER ⏭] button briefly (less than 1 second).**

[⏭] button: Advances to next track.

[⏮] button: Return to previous track.

The currently selected track number will be shown on the display.

## Fast-Forward/Rewind

The image can be controlled during playback.

This function can be operated by using either the panel buttons or the remote control.

### Using panel button

- 1 Turn the [TUNE TRACK] panel button until a beep is heard.**

Turn right: Fast-forward.

Turn left: Rewinds.

The fast-forward/rewind will continue while [TUNE TRACK] button is held. The fast-forward/rewind action will stop when button is released.

### Using remote control

- 1 Press the [⏮ CHAPTER ⏭] button until a beep is heard.**

[⏭] button: Advances to next track.

[⏮] button: Return to previous track.

The fast-forward/rewind will continue [⏮ CHAPTER ⏭] button is held. The fast-forward/rewind action will stop when the button is released.

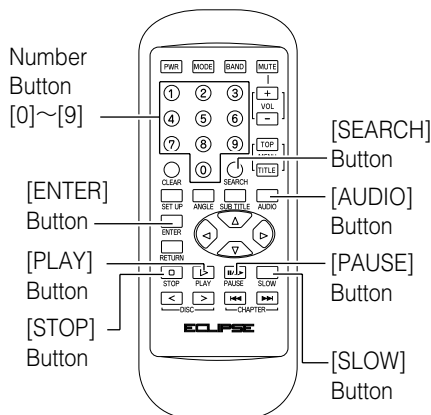

## Specifying a track to playback

A track of your choice is directly selectable.

This function can only be performed with the remote control.

- 1** Enter a track number with the [0] to [9] number button during video CD playback.

Entered numbers can be deleted with each pressing of the [CLEAR] button.

- 2** Press [ENTER] button.

Begins playing the selected track.

## Pausing/Advancing the video

This function can only be performed with the remote control.

- 1** Press the [PAUSE] button during video CD playback.

The video will pause.

The video will advance each time [PAUSE] button is pressed again while paused.

- 2** Press the [PLAY] button.

Restarts playback.

## Stopping playback

This function can only be performed with the remote control.

- 1** Press the [PAUSE] button during video CD playback.
- 2** Press the [PLAY] button.  
Restarts playback.

## Using slow motion

This function can only be performed with the remote control.

- 1** Press the [SLOW] button during video CD playback.  
The video will play in slow motion.
- 2** Press the [PLAY] button.  
Restarts playback.

## Switching sound output

Sound output may be switched between main sound and sub sound.  
This function can only be performed with the remote control.

- 1** Press the [AUDIO] button.

Mode will switch in the order shown below each time the button is pressed.

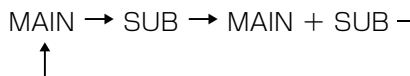

# How to operate multi-window display

The screen can be divided into two sections (left and right) to display video images, capture images\* taken from CD-R and Memory Stick.

\*: Includes images taken from CD-R and Memory Stick.

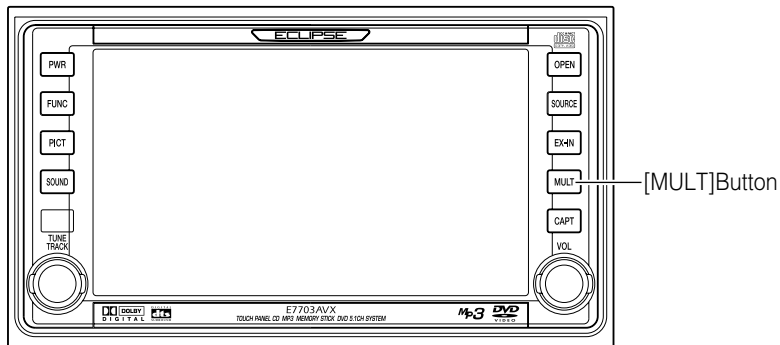

## Setting multi-window

- 1 Press (2 seconds or more) the [MULT] panel button.

Switches to multi-window setting mode.

When the power of the unit is turned ON for the first time or when it is switched ON after the battery is reconnected, capture images are displayed on the left and right of the screen.

- 2 Touch the **Pict** touch switch to select the display list.

Switches between display lists in the following order each time the **Pict** is touched.



Capture image\*1 → Multipurpose cameras image → Navigation screen



\*1: Includes images taken from CD-R and Memory Stick.



ATTENTION

- Blue back screen is displayed when unconnected equipment is selected.
- The same image cannot be displayed on left and right display sections simultaneously. (When the power is switched ON for the first time or it is switched ON after the battery is reconnected, both left and right display sections display capture images and the display will return to the previously set screen.)

- 3** Touch the **Sel** touch switch to select the capture image. (Only for capture image)

Every time the **Sel** touch switch is touched, stored images (a maximum of 6 files) are displayed sequentially.



- 4** Touch the **Pos** touch switch to select the display position.

Switches between display position in the following order each time the **Pos** is touched.

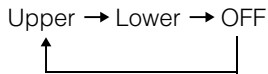

- 5** Press the [MULT] panel button to exit multi-display setting mode.

## Switching multi-window display

The previously set multi-window can be displayed on the audio operation screen.

Multi-windows cannot be activated when the navigation screen is displayed.

- 1** Touch the [MULT] panel button briefly (less than 1 second).

Multi-window display switches on or off each times the button is pressed.



Multi-windows cannot be activated when the navigation screen is displayed. In this case, turn off the multi-window display.

## Adjusting multi-window display size

The size of the multi-window display can be adjusted.

- 1** Touch the multi-window screen.

Switches between display size in the following order each time the screen is touched.

<Multi-window 1 (left)>

1/1.5 → 1/2 → 1/3



<Multi-window 2 (right)>

1/2 ↔ 1/3



## How to operate the receiver with an optional navigation system connected (In case of using the receiver as monitor for navigation system)

When a navigation system is connected, the screen can be used as the navigation monitor.

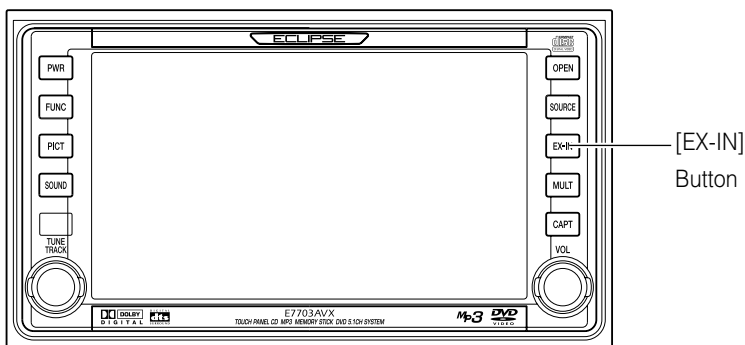

## Using the receiver as monitor for navigation system

### 1 Press the [EX-IN] panel button.

Switches between navigation screen and audio operation screen each time the button is pressed.



ATTENTION

- Refer to the navigation system operation manual for details of navigation system operations.
- Only images output from navigation systems adopting NTSC (3.58MHz) methods are compatible with this unit. (This unit does not support any other methods.)



Caution

The navigation system connecting cables are designed exclusively for the visual navigation system equipment. Do not use the connecting cables for other visual equipment. Doing so may damage the unit. Please contact a dealer for details.

## How to operate the receiver with an optional CD changer connected

This section covers the operation an optional CD changer that is connected to the receiver.

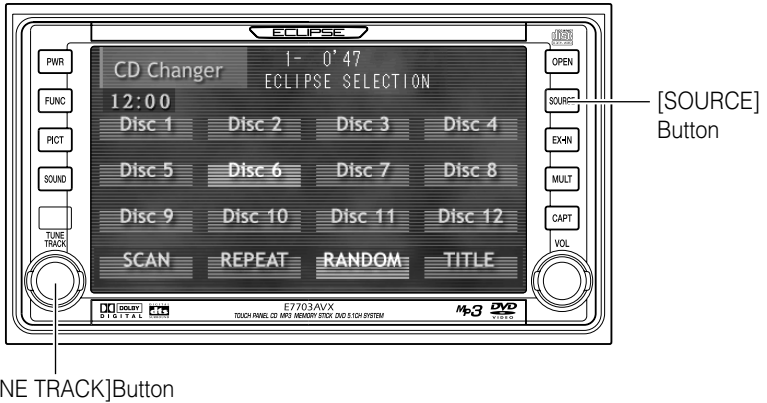

[TUNE TRACK]Button

[SOURCE] Button

### Listening to a CD

- 1 Press the [SOURCE] panel button.  
Switches display to the Audio Source Menu screen.
- 2 Touch the **CD Changer** touch switch.  
Switches CD changer screen and starts playback.

### Advancing to the next track or returning to the beginning of the track being played

- 1 Turn the [TUNE TRACK] panel button briefly (less than 1 second).  
Turn right: Advances to the next track.  
Turn left: Returns to the beginning of the track being played. (Repeat turning for previous tracks.)

## Fast-Forward/Rewind

---

- 1 Turn the [TUNE TRACK] panel button until a beep is heard.

Turn right: Fast-forwards.

Turn left: Rewinds.

The fast-forward/rewind will continue while [TUNE TRACK] button is held. The fast-forwarding/rewinding action will stop when the button is released.

## Playing the beginning of tracks (SCAN)

---

- 1 Touch the **SCAN** touch switch.

Touching the **SCAN** touch switch causes the changer to move up to the next track and play it for 10 seconds, then move up to the next track and play it for 10 seconds, and so on, one CD, until the switch is pressed again.

Hold the switch until the [DISC SCAN] display appears to play the first 10 seconds of the first of every CD loaded.

## Repeating the same track (REPEAT)

---

- 1 Touch the **REPEAT** touch switch.

Touching the **REPEAT** touch switch causes the changer to repeat the track currently being played, until the switch is pressed again.

Hold the switch until the [DISC REPEAT] display appears to repeat all tracks on the CD being played.



## Playing tracks in random order (RANDOM)

- 1 Touch the **RANDOM** touch switch.

Touching the **RANDOM** touch switch causes the changer to play the tracks on the currently playing CD in random order.

Hold the switch until the [ALL RANDOM] display appears to play tracks from all of CDs loaded in the currently selected changer, in random order.



- Doing random playback, touch the **REPEAT** touch switch to repeat the track being played. To cancel repeat play (go back to random play), touch the **REPEAT** touch switch again.

During playback a particular track: The track being played is played repeatedly.

During searching: The following track is played repeatedly.

- Occasionally the same track happens to be played (selected) two or more times in a row; this is normal operation and is no sign of a problem.

## Specifying a CD to play

A CD of your choice is directly selectable out of the loaded discs.

- 1 Touch the touch switch from **DISC1** to **DISC12**.

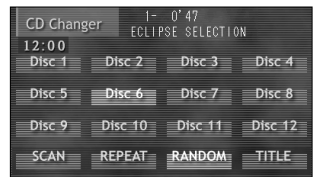

## Creating a title for a CD

A CD title can be created and displayed.



- 30 title can be stored.
- A maximum of 18 characters may be entered per title.

### 1 Touch the **TITLE** touch switch briefly (less than 1 second).

The screen will switch to the disc title setting mode. Default character type is upper-case alphabet.



### 2 Touch one of the switch **ABC** , **abc** , **123/!"#** touch switch.

**ABC** : Default character type is upper-case alphabet.

**abc** : Default character type is lower-case alphabet.

**123/!"#** : Default character type is numerical, symbol.

### 3 Touch the character touch switch.



- To enter symbols, touch the **!"#** touch switch when the numerical character input is selected.
- Touch the **RETURN** touch switch to delete the character that was just entered.
- To change the type of character to be entered, repeat step **2** and **3**.
- A maximum of 18 characters may be entered per title.

Upper case characters,  
alphabet characters

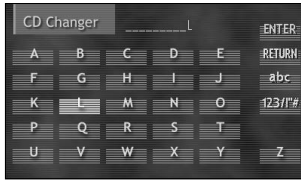

Lower case characters,  
alphabet characters

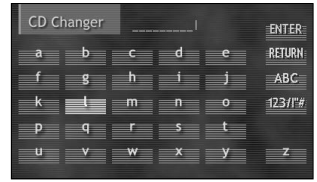

Numerical character



Symbol



- 4 Touch the **ENTER** touch switch to exist disc title setting mode.  
The disc title is now memorized.

## Deleting a previously created title

- 1 Touch (2 seconds or more) the **TITLE** touch switch.  
The title has now been deleted.



## *How to use the remote control*

### **Precautions in use of the remote control**

- Be careful when handling the control, especially because it is small and light. Dropping or striking it hard may damage it, wear out the battery or cause a malfunction.
- Keep the remote control free of moisture, dust and water. Do not subject it to shock.
- Do not place the remote control unit where it will get hot, such as on the dashboard or near a heater vent. Allowing the remote control unit to overheat may warp its case or cause other problems.
- Do not operate the remote control unit while driving because doing so could cause an accident.
- When using the remote control, point it directly at the remote control light receptor.
- The light receptor may not operate correctly if it is exposed to bright light such as direct sunlight.
- Remove the batteries from the remote control unit whenever it is not to be used for a long time.

### **Cleaning the remote control**

- Use a dry cloth to keep the unit clean. If the remote control unit gets extremely dirty, clean it with a cloth moistened in dilute liquid detergent. Do not use alcohol or thinner; these compounds may damage the finish.
- In no event should benzine or thinner be used. These substances will damage the case or finish.

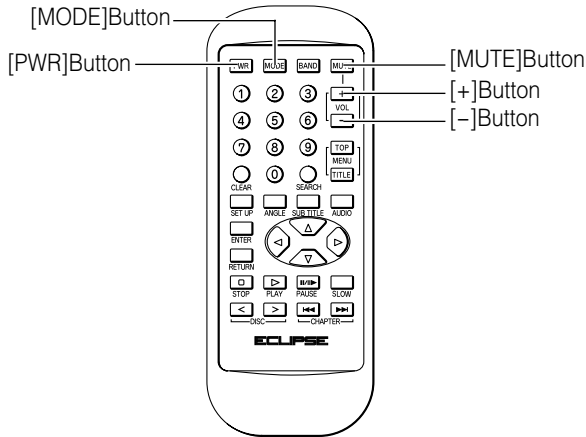

## Turning the power on/off

- 1 Press the [PWR] button.

The power turns on or off each time the button is pressed.

## Adjusting the audio volume

- 1 Press the [+] or [-] button.

[+] button: Increases the volume.

[-] button: Decreases the volume.

### Cutting the volume instantly (muting)

Press the [MUTE] button to cut the volume or restore it instantly.

## Switching playback modes

- 1 Press the [MODE] button.

Press the button to switch modes in the following sequence:

AM → FM → DVD → CD → Memory Stick



The indicator will skip a unit that has no connected.

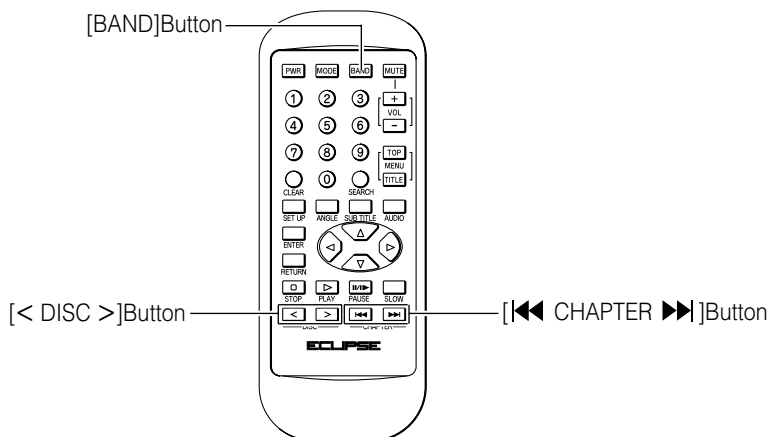

## How to play the tuner

### Selecting FM/AM band

#### 1 Press the [BAND] button.

Each press will switch tuner modes from FM1 → FM2 → AM1 → AM2.

### Selecting a station (manually or automatically)

A short press of the button will allow manual station tuning. Pressing for more than one second will start automatic tuning.

#### 1 Press the [CHAPTER] button.

[>>>] button: Tunes to higher frequency stations.

[<<<] button: Tunes to lower frequency stations.

### Selecting preset stations

A total of six stations may be selected (preset tuning) out of those already set in memory through the main unit. (Refer to "Presetting stations manually", page 70)

#### 1 Press the [< DISC >] button.

[>] button: Tunes to higher frequency stations.

[<] button: Tunes to lower frequency stations.

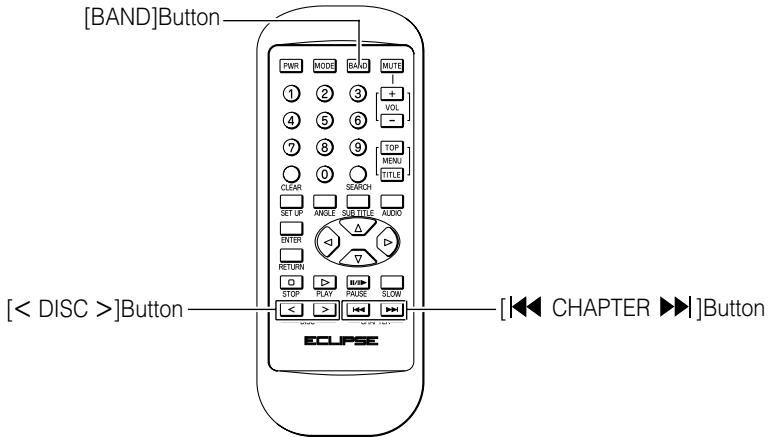

## How to play CD

### Advancing to the next track or returning to the beginning of the track being played

**1 Press the [ CHAPTER ] button.**

[ ►► ] button: Advances to the next track.

[ ◀◀ ] button: Returns to the beginning of the track being played.  
(Repeat pressing for previous track.)



Hold the [ ►► ] button down to fast forward, or [ ◀◀ ] button to rewind through the track being played.

### Skipping to the next or previous disc

**1 Press the [ < DISC > ] button.**

[ > ] button: Selects the next higher number disc.

[ < ] button: Selects the next lower number disc.

### Switching disc mode

**1 Press the [BAND] button.**

When CD changer is connected, press the [BAND] button to change mode CD player CD changer.

The indicator will skip a changer or player that has no discs loaded.

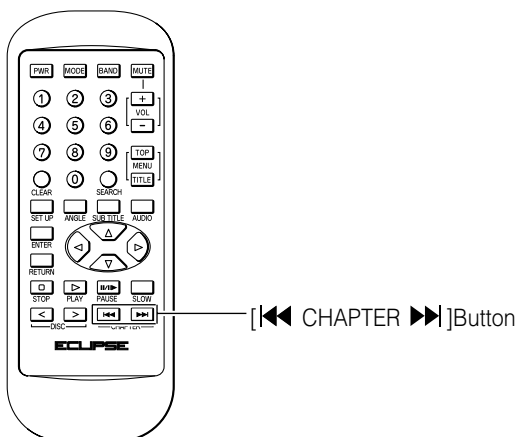

## How to play Memory Stick

Advancing to the next track or returning to the beginning of the track being played

- 1 Press the [ <<< CHAPTER >>> ] button.
  - [ >>> ] button: Advances to the next track.
  - [ <<< ] button: Returns to the beginning of the track being played.  
(Repeat pressing for previous track.)



## Replacing the battery



Warning

To prevent accidents, store batteries out of the reach of children. If a child has swallowed one, consult a doctor immediately.

Use two AA-size batteries.

- 1 Remove the back cover of the remote control unit by gently pressing and sliding it in the direction indicated by the arrow.

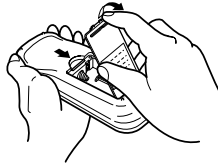

- 2 Install the two batteries provided into the compartment as illustrated inside the compartment.

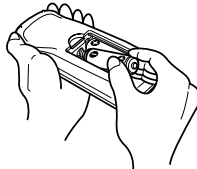

- 3 Return the back cover into place by sliding it in the direction indicated by the arrow.

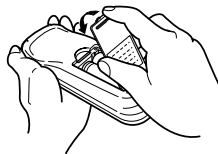

Caution

- Be extremely careful not to swallow the battery.
- The battery life is approximately one year. If the remote control unit does not operate correctly or if the button lamp gets dim, replace the batteries.
- Be sure to orient the batteries correctly so that the positive and negative poles match the diagram.
- Do not use one new battery and one old one; use two new batteries.
- Use only two of the same kind of battery.
- If any liquid is seen leaking from the batteries, remove both batteries and dispose of them properly. Thoroughly clean the battery compartment with a dry cloth. Then install new batteries.

# Troubleshooting

Check the following before asking for service.

## Message displays

If any of the following messages are displayed, check the unit while referring to the Cause and Remedy columns.

Message	Causes	Remedial action to take
Reading disc.	The unit is identifying the type of disc.	Wait until the unit has finished identifying the type of disc.
Please check disc.	The disc is dirty or upside-down, or it is a type of disc that cannot be played back.	Clean the disc if it is dirty. Insert the disc correctly if it is upside-down. Check that the disc is of a type that can be played back.
There is no corresponding language code.	The language code selected does not match the DVD.	Check that the language code matches the DVD.
Incorrect PIN	An incorrect PIN was entered.	Enter the correct PIN.
Can not read disc. Please check disc.	A DVD with an incompatible region code has been inserted.	Insert a DVD with a compatible region code.
Please eject disc. (*1)	The CD•DVD player cannot work for some reason.	Eject the disc.
Playing paused due to overheating. (*2)	The temperature of the CD•DVD player is abnormally high.	Wait for a while until the temperature drops.
While vehicle is in motion, the video portion has been disabled.	You tried to view the video while driving.	Stop the vehicle in a safe place and apply the parking brake before viewing the video.

\*1: If the DVD player still will not work after the disc is ejected, contact the place of purchase.

\*2: If this happens, wait for a while. When the temperature inside the unit returns to normal, the message will disappear and playback will start. If the message does not disappear after a long period of waiting, contact the place of purchase.

Message	Causes	Remedial action to take
You can not register anymore. Memory for CD titles is full.	The number of CD disc titles registered has reached the maximum.	Delete an existing disc title registration before adding another one.
Checking Memory Stick.	The unit is checking the Memory Stick to verify that it is recordable.	Wait until the verification is complete.
Please format Memory Stick.	An MG Memory Stick with no Hi-Fi directory formatting has been inserted.	Use the unit to format the Memory Stick.
Please Insert Magic Gate Memory Stick.	You started to record to a Memory Stick that is not an MG Memory Stick.	This unit can only record onto MG Memory Sticks. Use MG Memory Sticks for recording.
	You tried to start recording when no MG Memory Stick was inserted.	Insert an MG Memory Stick and then start recording
Please check Memory Stick.	An MG Memory Stick containing incompatible audio files has been inserted.	Insert an MG Memory Stick containing compatible audio files.
	Static electricity has made the Memory Stick unplayable.	Wait for a brief period and then retry.
No Music data.	An MG Memory Stick containing no music data has been inserted.	Insert an MG Memory Stick containing music data.

Message	Causes	Remedial action to take
Memory Stick error.	You tried to play back an incorrectly formatted Memory Stick.	Use the unit to format the Memory Stick.
File error.	An MG Memory Stick containing incompatible files has been inserted.	Insert an MG Memory Stick containing compatible files.
Memory Stick is locked.	The write protection switch is locked.	Unlock the write protection switch.
Please check Memory Stick free space.	The Memory Stick is full.	Delete some of the music data from the Memory Stick and then start saving again.
Can not record.	You tried to record music from an audio CD such as a CD-R or CD-RW onto the MG Memory Stick.	This unit is compatible with SCMS/SDMI standards, and so it cannot record music from audio CDs such as CD-Rs and CD-RWs. Recording from dts-CDs is also not possible.
Recording is cancelled. Data is deleted.	Recording stopped for some reason.	Check the MG Memory Stick.
No data.	No playable data is present.	Insert an MG Memory Stick containing music data.
Can not read disc due to guard.	You tried to play back data that includes a playback guard.	Data that includes a playback guard cannot be played back.
Can not record anymore.	You tried to record more than the maximum number of tracks (400) onto a MG Memory Stick.	Delete some of the Memory Stick data or use a different Memory Stick for recording.
This Memory Stick is not available.	An incompatible Memory Stick has been inserted.	Check that the Memory Stick can be used with this unit. (Refer to page 17.)
Can not read the format.	You tried to play back an MG Memory Stick recorded using an ATRAC3 Plus.	This unit cannot play back ATRAC3 Plus recordings. Play back Memory Sticks that were recorded using ATRAC3.

Message	Causes	Remedial action to take
Can not edit title.	You tried to edit a title or artist's name that was entered or edited using a computer.	Titles and artist's names that were entered or edited using a computer cannot be edited using this unit.
Can not edit Artist name.		
No disc in the magazine.	There is no disc in the magazine or player.	Load a disc in the magazine.

## Before asking for repairs

Slight differences in operation can sometimes be mistaken for malfunctions, so check the following table before asking for any repairs.

If the following fail to solve the problem, contact the place of purchase.

Mode	Problem	Causes	Remedial action to take	Refer to page
Common to all	The screen is dark for a brief period when the power is turned on at low temperatures.	This is a characteristic of LCDs.	This is not a malfunction. Wait for a brief period.	—
	The display is distorted for a brief period after the power is turned on.	This is a characteristic of LCD backlighting.	This is not a malfunction. The display will stabilize after a brief period.	—
	Dead or weak sound	Is the volume control up sufficiently?	Turn up the volume control.	31, 133
		Is the muting function in effect (MUTE)?	Cancel the muting (MUTE) function.	133
		Is the fader or balance control set far to one side?	Readjust the fader and balance controls to more normal positions.	34
	Other probable causes include broken audio-signal wiring or a faulty speaker.	Have your dealer check the problem.	—	

Mode	Problem	Causes	Remedial action to take	Refer to page
Common to all	Power does not turn on.	Are too many electrical items installed, causing a lack of power?	Have your dealer check the problem.	—
		Other probable causes include a run-down car battery, broken power or interconnection wiring.	Have your dealer check the problem.	—
	Frequencies or titles set in memory are deleted.	Has the car battery been disconnected for repair or checked out?	Reenter them into memory.	—
		Are too many electrical items installed and causing lack of available power?	Have your dealer check the problem.	—
		Other probable causes include run-down car battery, broken power or interconnection wiring.	Have your dealer check the problem.	—
	No guide tone sounds.	Is the guide tone disabled?	Enable the guide tone.	67
	Loaded images do not appear as background	Is the size and file format of the loaded image correct?	Check the size and file format of the loaded image.	—

Mode	Problem	Causes	Remedial action to take	Refer to page
TUNER	Receives no stations, or receives static noise.	Is the antenna retracted?	Extend the antenna.	—
		Is the tuner correctly tuned to a station?	Tune to a station.	68
		Are you driving outside the service area of your preset stations?	Tune to a local station. (Please note, there may be no local stations servicing the area where you are currently driving.)	68
		Are you operating other equipment with a computer, or a mobile phone, in your vehicle at the same time as your receiver?	Avoid operating such equipment while using the receiver.	—
		Other problems may include a loose or disconnected antenna cable, a bad antenna cable or a bad	Have your authorized Eclipse retailer check the problem.	—
C D · DVD	The disc cannot be inserted. The disc is ejected as soon as it is inserted. Or, the disc cannot be ejected.	Is an extra label or seal applied to the disc?	Do not apply labels or seals to the disc.	—
		Are there rough edges, deformations or damaged areas on the disc?	Try inserting another disc. Removed any burrs. Do not use a deformed or damaged disc.	—

Mode	Problem	Causes	Remedial action to take	Refer to page
C D · DVD	Sound skips around. Sound is intermittent. Sound is bad in quality.	Is the disc damaged? (scratched, warped, etc.)	Try another disc. Do not play a damaged disc.	—
		Is the disc clean?	Clean the disc.	16
		Is the player mounted at a proper angle? Is the player mounted loosely?	Have your dealer check it out.	—
		Are you driving over a rough surface?	Avoid playback while driving over rough surfaces.	13
	Disc cannot be played back.	Condensation has formed.	Wait for a brief period and then retry.	—
		The disc is badly scratched or warped.	Insert a different disc.	—
		The disc is extremely dirty.	Clean the disc.	16
		The disc is upside-down.	Insert the disc correctly.	22
		An incompatible disc has been inserted.	Insert a compatible disc.	13
	No images appear.	The vehicle is moving. (Stop the vehicle and apply the parking brake.)	As a safety measure, video images cannot be viewed while the vehicle is moving. Only sound can be heard. If the images are still not visible after you stop the vehicle and apply the parking brake, ask the place of purchase for an inspection to be made.	—
		Some other cause such as LCD backlight (fluorescent tube) failure or a flat vehicle battery may be the reason.	Ask the place of purchase for an inspection to be made.	—



# Specifications

## <GENERAL>

Power Output	50W x 4 (Max.)
Output Level/Impedance	4Ω
LINE OUT Output Level	180mV/-20dB
Power Supply	13.2V DC (11-16V)
Current Drain	2A(0.5W)
Dimensions (W x H x D)	7" x 4" x 6-1/2" (180 x 100 x 165 mm)
Mass (Weight)	2.8 kg

## <DISPLAY>

Liquid Crystal Panel	5.8" wide (16: 9), low-glare panel
Display Dimensions (W x H; Diagonal)	5" x 3"; 6" (127.2 x 71.8; 146mm)
Total Number of Dots	280,800 dots (234 vertical x 1,200 horizontal)
Useful Pixels	99.99%, minimum
Display Method	Transmission type, color filter system
Drive System	TFT (thin-film transistor) active matrix system
Operating Temperature Range	-20°C~+65°C (-4°F~149°F)
Storage Temperature Range	-40°C~+85°C (-40°F~185°F)

## <CD SECTION>

Frequency Response	20~20,000Hz
Dynamic Range	93dB
S/N Ratio	96dB (IHF-A Network)
Total Harmonic Distortion	0.03% (0dB, 1kHz)
Wow & Flutter	Below Measurable Limits

## <MEMORY STICK PLAYER SECTION>

Frequency Response	20~20,000Hz
Dynamic Range	93dB
S/N Ratio	96dB
Total Harmonic Distortion	0.03% (0dB, 1kHz)

## &lt;FM TUNER&gt;

Frequency Range	87.5~108.0MHz (50 kHz step)
Usable Sensitivity	12dBf
Frequency Response	30~15,000Hz
Stereo Separation	38dB

## &lt;AM TUNER&gt;

Frequency Range	522~1,629kHz (9kHz step)
Usable Sensitivity	22 $\mu$ V

## &lt;DSP SECTION&gt;

Frequency Range	20~20,000Hz
S/N Ratio	90dB
Time Alignment: Function	F-L/R, R-L/R, Center
Time Alignment: Distance	0.0m~0.4m (0.05m step)
Time Alignment: Level	-6dB~+6dB (1dB step)
GEQ: Adjustment median frequency	63~12,000Hz
GEQ: Tone Action	$\pm$ 10dB



- Some of the contents of this manual may differ from actual product features as a result of changes to product specifications and appearance.
- This equipment includes copyright protection technology used in accordance with US patents and other intellectual property rights owned by Macrovision Corporation and other entities. Use of this copyright protection technology requires approval from Macrovision Corporation and the technology must not be used for audiovisual purposes aside from general household use without special approval from Macrovision Corporation. Modification and disassembly of this technology is prohibited.
- Manufactured in compliance with rights granted from Dolby Laboratories. Dolby and the double D mark are trademarks of Dolby Laboratories.
- DTS is a trademark of Digital Theater System, Inc.



This device complies with part 15 of the FCC Rules. Operation is subject to the condition that this device does not cause harmful interference.

CUSTOMER NOTICE

Please retain this booklet and write in the serial number of your E7703AVX for identification. The serial number is labeled or stamped on the chassis.

Serial No. \_\_\_\_\_

